

Möbel LETZ

Finden und Wohlfühlen



Prospekt

Fresh von puris - Badezimmer in Quarzgrau & Polarweiß

Wichtiger Hinweis für Sie als Verbraucher

Etwaige Hinweise des Herstellers in dieser Produktinformation, die sich auf die Gewährleistung beziehen, haben für Sie keinerlei Bindungswirkung und können von Ihnen ignoriert werden. Ihre gesetzlichen Gewährleistungsrechte als Verbraucher uns gegenüber, als Ihrem Verkäufer, werden dadurch in keiner Weise berührt oder eingeschränkt. Sie können sich wegen aller Mängel jederzeit an uns wenden. Darüber hinaus gehende Herstellergarantien bleiben natürlich unberührt.

Möbel Letz GmbH
Am Gewerbepark 11
06895 Zahna-Elster

Tel.: 035383 - 6018 50

Fax.: 035383 - 6018 17



puris
BAD • MÖBEL



Follow us on
Instagram
@puris_bad

www.puris.de

Abbildungen und Angaben sind unverbindlich. Technische Änderungen vorbehalten.
Illustrations and specifications are without obligation. Technical modifications reserved.
Reproductions et données techniques sans engagement de notre part. Sous réserve de modifications techniques.
Afbeeldingen en specificaties kunnen afwijken. Technische wijzigingen voorbehouden.



2022/2023

new
generation



protection 1

Bestechend klare Formen, geradliniger Charakter, puristischer Keramik-Waschtisch
 Impressively clear shapes, straightforward character, purity of ceramic washbasins
 Des formes claires, un style simple, un plan de toilette en céramique épuré
 Boeiend strakke vormen met een puristische keramische wastafel



Frontdekore | Front finishes | Façades | Front kleuren

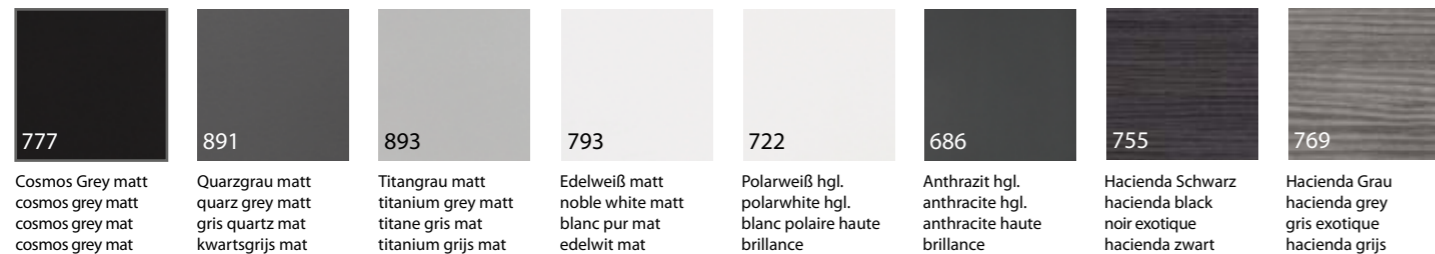

777
Cosmos Grey matt
cosmos grey matt
cosmos grey mat
cosmos grey mat

891
Quarzgrau matt
quarz grey matt
gris quartz mat
kwartsgrijs mat

893
Titangrau matt
titanium grey matt
titane gris mat
titanium grijs mat

793
Edelweiß matt
noble white matt
blanc pur mat
edelwit mat

722
Polarweiß hgl.
polarwhite hgl.
blanc polaire haute
brillance
hoogglans wit

686
Anthrazit hgl.
anthracite hgl.
anthracite haute
brillance
hoogglans antraciet

755
Hacienda Schwarz
hacienda black
noir exotique
hacienda zwart

769
Hacienda Grau
hacienda grey
gris exotique
hacienda grijs



670
Halifax Eiche
halifax oak
chêne Halifax
halifax eiken

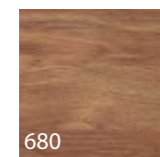

680
Charleston Eiche
charleston oak
chêne Charleston
charleston eiken

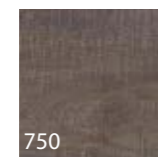

750
Cardiff Eiche
cardiff oak
chêne Cardiff
cardiff eiken

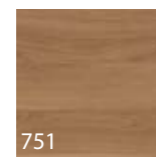

751
Cuneo Eiche Braun
cuneo oak brown
Cuneo imitation
chêne marron
cuneo eiken bruin

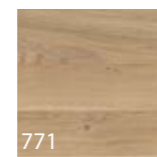

771
Cuneo Eiche Natural
cuneo oak natural
Cuneo imitation
chêne naturel
cuneo eiken naturel



785
Eiche Natur
Nachbildung
natural oak effect
imitation chêne naturel
eiken naturel folie

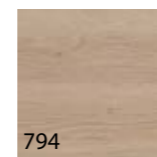

794
Eiche Sand
sand oak
chêne sable
zand eiken

Korpusdekore | Carcass colours | Corps de meuble | Corpus kleuren

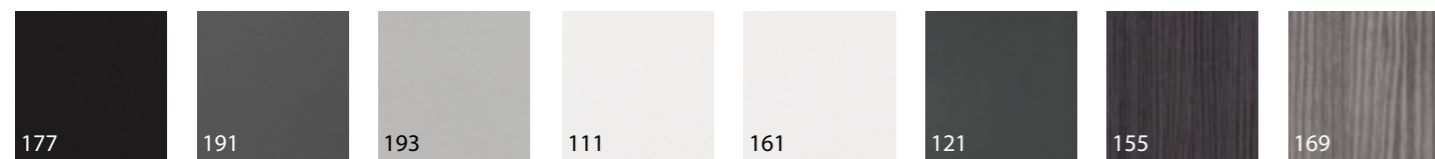

177
Cosmos Grey matt
cosmos grey matt
cosmos grey mat
cosmos grey mat

191
Quarzgrau matt
quarz grey matt
gris quartz mat
kwartsgrijs mat

193
Titangrau matt
titanium grey matt
titane gris mat
titanium grijs mat

111
Weiß matt
white matt
blanc mat
wit mat

161
Weiß hgl.
white hgl.
blanc haute brillante
hoogglans wit

121
Anthrazit hgl.
anthracite hgl.
anthracite haute
brillance
hoogglans antraciet

155
Hacienda Schwarz
hacienda black
noir exotique
hacienda zwart

169
Hacienda Grau
hacienda grey
gris exotique
hacienda grijs



170
Halifax Eiche
halifax oak
chêne Halifax
halifax eiken

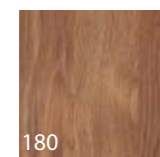

180
Charleston Eiche
charleston oak
chêne Charleston
charleston eiken

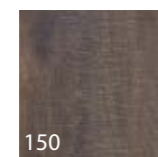

150
Cardiff Eiche
cardiff oak
chêne Cardiff
cardiff eiken

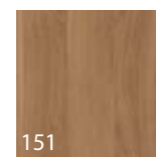

151
Cuneo Eiche Braun
cuneo oak brown
Cuneo imitation
chêne marron
cuneo eiken bruin

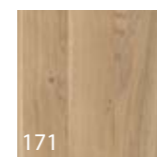

171
Cuneo Eiche Natural
cuneo oak natural
Cuneo imitation
chêne naturel
cuneo eiken naturel



185
Eiche Natur
Nachbildung
natural oak effect
imitation chêne naturel
eiken naturel folie



194
Eiche Sand
sand oak
chêne sable
zand eiken

Planungsbeispiele Planning examples | Exemples de composition | Sets

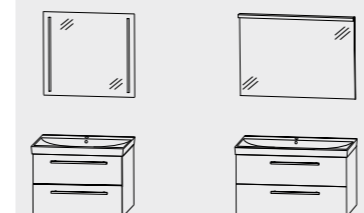

FSB-4470-01
WTM-5107-1
WUA-3770-79
710 mm

FSA-4310-12
WTM-5110-1
WUA-3710-79
1010 mm

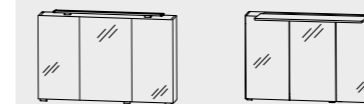

S2A-432S-10
WTM-5112-1
WUA-3712-79
1210 mm



SET-4312-05
WTM-512D-1
WUA-372D-79
1210 mm

Ergänzungsschränke | Additional cabinets | Meubles complémentaires | Losse kasten

Hochschränke | tall units | colonnes | hoge kasten

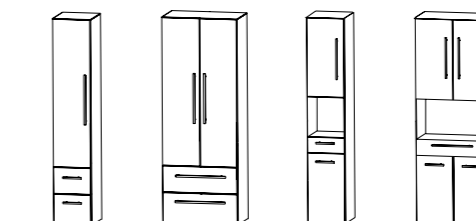

300°/600 x 1600 mm

Mittelschränke | central units | armoires moyennes | middenkasten

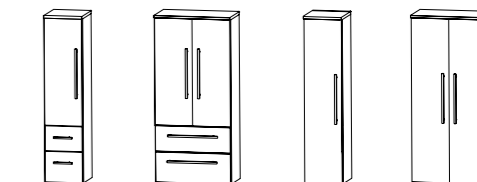

300°/600 x 1136 mm

Highboards | highboards | highboards | highboards

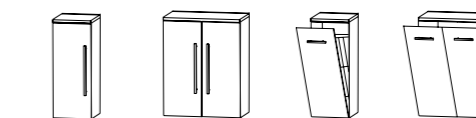

300°/600 x 656 mm

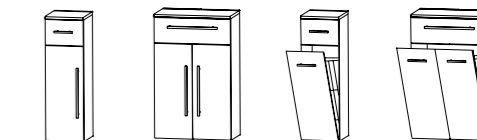

300°/600 x 816 mm

Ober-/Unterschränke | wall/base units | éléments suspendus/bas | boven-/onderkasten

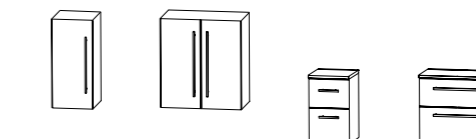

300°/600 x 640 mm

300°/600 x 496 mm

Breite x Höhe in mm
Width x height in mm
Largeur x hauteur in mm
Breedte x hoogte in mm

- ° Schränke auch in 400 mm Breite erhältlich.
- ° Cabinets also available with a width of 400 mm.
- ° Les armoires sont également disponibles avec une largeur de 400 mm.
- ° Kasten ook verkrijgbaar in 400 mm breedte.



Nr. 294
Stangengriff chrom
handle chrome
poignée barre chrome
stangengreep chrom

- Auszug aus dem Typenplan
- Die Artikelnummern der Ergänzungsschränke entnehmen Sie aus den Typenlisten.
- Türen · Auszüge · Schubkästen mit Dämpfung
- Part numbers of the available options
- Please consult the full range available for the article numbers of the add-on cabinets.
- Doors · pull out units · drawers with buffered closing

- Extrait du plan type
- Les références des meubles complémentaires sont présentes dans notre liste d'articles.
- Portes · tiroirs · coulissants avec amortisseur
- Getoonde kasten zijn een selectie uit de kast mogelijkheden
- De bestelcodes van de losse kasten kunt vindt u bij de losse elementen.
- Deuren en lades met softclose







d.light

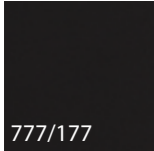
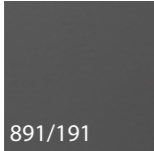
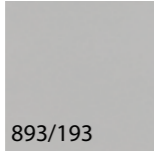
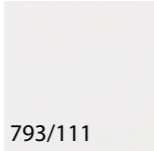
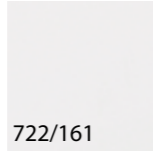

Funktionalität trifft zeitloses Design
Functionality meets timeless design
La fonctionnalité alliée à un design intemporel
Funktionaliteit met een tijdloos design

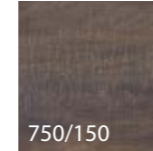
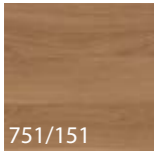

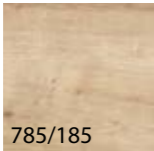



Frontdekore | Front finishes | Façades | Front kleuren
Korpusdekore | Carcass colours | Corps de meuble | Corpus kleuren

 777/177	 891/191	 893/193	 793/111	 722/161	 670/170	 750/150
Cosmos Grey matt cosmos grey matt cosmos grey mat cosmos grey mat	Quarzgrau matt quarz grey matt gris quartz mat kwartsgrijs mat	Titangrau matt titanium grey matt titane gris mat titanium grijs mat	Edelweiß matt / Weiß matt noble white matt / white matt blanc pur mat / blanc mat edelwit mat / wit mat	Polarweiß hgl. / Weiß hgl. polarwhite hgl. / white hgl. blanc polaire haute brillance / blanc haute hoogglans wit	Halifax Eiche halifax oak chêne Halifax halifax eiken	Cardiff Eiche cardiff oak chêne Cardiff cardiff eiken
 751/151	 771/171	 785/185				
Cuneo Eiche Braun cuneo oak brown Cuneo imitation chêne marron cuneo eiken bruin	Cuneo Eiche Natural cuneo oak natural Cuneo imitation chêne naturel cuneo eiken naturel	Eiche Natur Nachbildung natural oak effect imitation chêne naturel eiken naturel folie				



	
Nr. 294 Stangengriff chrom handle chrome poignée barre chrome stangengreep chrom	Nr. 343 Griffleiste alu matt strip handle alu matt profilé poignée alu mat greeplijst alu mat
	
Nr. 334 Griffleiste chrom strip handle chrome profilé poignée chrome greeplijst chrom	Nr. 344 Griffleiste schwarz matt strip handle black matt profilé poignée noir mat greeplijst zwart mat

Planungsbeispiele
Planning examples | Exemples de composition | Sets

 FSA-417B-30 SET-DL70-1* 732 mm	 FSA-411B-01 SET-DL10-1* 1032 mm
 SET-432D-02 SET-DL12-1* 1232 mm	 SET-432D-01 SET-DL2D-1* 1232 mm

* auch mit LED-Beleuchtung erhältlich
* also available with LED lighting
* aussi disponible avec éclairage LED
* ook mogelijk met LED verlichting

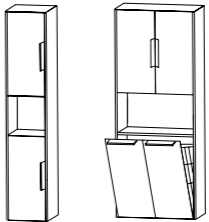
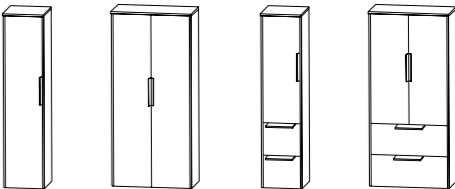
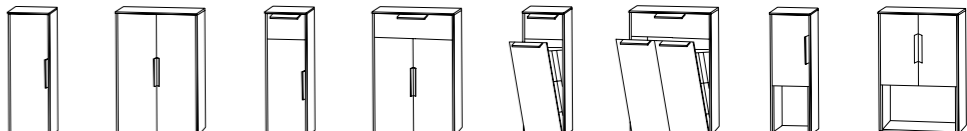
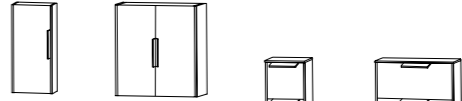

Ergänzungsschränke | Additional cabinets | Meubles complémentaires | Losse kasten

<p>Hochschränke tall units colonnas hoge kasten</p>  <p>320°/620 x 1290 mm</p>	<p>Mittelschränke central units armoires moyennes middenkasten</p>  <p>325°/625 x 1630 mm</p>
<p>Highboards highboards highboards highboards</p>  <p>325°/625 x 810 mm</p>	
<p>Ober-/Unterschränke wall/base units éléments suspendus/bas boven-/onderkasten</p>  <p>320°/620 x 640 mm 325°/625 x 490 mm</p>	
<p>° Schränke auch in 420 / 425 mm Breite erhältlich. ° Cabinets also available with a width of 420 / 425 mm. ° Les armoires sont également disponibles avec une largeur de 420 / 425 mm. ° Kasten ook verkrijgbaar in 420 / 425 mm breedte.</p>	
<p>Breite x Höhe in mm Width x height in mm Largeur x hauteur in mm Breedte x hoogte in mm</p>	

- | | |
|--|---|
| <ul style="list-style-type: none"> - Auszug aus dem Typenplan - Die Artikelnummern der Ergänzungsschränke entnehmen Sie aus den Typenlisten. - Türen · Auszüge · Schubkästen mit Dämpfung | <ul style="list-style-type: none"> - Extrait du plan type - Les références des meubles complémentaires sont présentes dans notre liste d'articles. - Portes · tiroirs · coulissants avec amortisseur |
| <ul style="list-style-type: none"> - Part numbers of the available options - Please consult the full range available for the article numbers of the add-on cabinets. - Doors · pull out units · drawers with buffered closing | <ul style="list-style-type: none"> - Getoonde kasten zijn een selectie uit de kast mogelijkheden - De bestelcodes van de losse kasten kunt vindt u bij de losse elementen. - Deuren en lades met softclose |



unique

Unschlagbare Kombination aus filigranen Details mit enormer Anpassungsfähigkeit
 Unbeatable combination of fine details with enormous adaptability
 Alliance incomparable de délicats détails et de grande adaptabilité
 Onverslaanbare combinatie van filigrane details met enorme aanpassingsmogelijkheden





Griffprofil
in Korpusdekor
handle profile
in carcass colour
profil de poignée
en coloris de corps
griepprofiel
in corpus kleur



Nr. 324
Griffleiste chrom
strip handle chrome
profilé poignée chrome
grieplijst chrom

Frontdekore | Front finishes | Façades | Front kleuren

775 Stahl Dunkel matt steel dark matt acier sombre mat staal donker mat	793 Edelweiß matt noble white matt blanc pur mat edelwit mat	722 Polarweiß hgl. polarwhite hgl. blanc polaire haute brillance hoogglans wit	679 Betonoptik concrete imitation aspect béton betonoptiek	670 Halifax Eiche halifax oak chêne Halifax halifax eiken	750 Cardiff Eiche cardiff oak chêne Cardiff cardiff eiken	751 Cuneo Eiche Braun cuneo oak brown Cuneo imitation chêne marron cuneo eiken bruin	771 Cuneo Eiche Natural cuneo oak natural Cuneo imitation chêne naturel cuneo eiken naturel	794 Eiche Sand sand oak chêne sable zand eiken

Korpusdekore / Seitenaufdopplungsdekore | Carcass colours / side doubling colours
Corps de meuble / coloris de doublage | Corpus kleuren / wangen kleuren

175 Stahl Dunkel matt steel dark matt acier sombre mat staal donker mat	111 Weiß matt white matt blanc mat wit mat	161 Weiß hgl. white hgl. blanc haute brillance hoogglans wit	179 Betonoptik concrete imitation aspect béton betonoptiek	170 Halifax Eiche halifax oak chêne Halifax halifax eiken	150 Cardiff Eiche cardiff oak chêne Cardiff cardiff eiken	151 Cuneo Eiche Braun cuneo oak brown Cuneo imitation chêne marron cuneo eiken bruin	171 Cuneo Eiche Natural cuneo oak natural Cuneo imitation chêne naturel cuneo eiken naturel	194 Eiche Sand sand oak chêne sable zand eiken

Waschtischplatten- und Abdeckplattendekore
Washbasin top and top cover colours | Coloris plan de toilette pour vasque à poser et coloris
de plateaux de recouvrement | Wastafelplaat en afdeklad kleuren

175 Stahl Dunkel matt steel dark matt acier sombre mat staal donker mat	111 Weiß matt white matt blanc mat wit mat	179 Betonoptik concrete imitation aspect béton betonoptiek	170 Halifax Eiche halifax oak chêne Halifax halifax eiken	150 Cardiff Eiche cardiff oak chêne Cardiff cardiff eiken	151 Cuneo Eiche Braun cuneo oak brown Cuneo imitation chêne marron cuneo eiken bruin
171 Cuneo Eiche Natural cuneo oak natural Cuneo imitation chêne naturel cuneo eiken naturel	174*1 Hunton Eiche hunton oak chêne Hunton hunton eiken	185 Eiche Natur Nachbildung natural oak effect imitation chêne naturel	194 Eiche Sand sand oak chêne sable zand eiken	143*2 Schieferoptik slate imitation aspect ardoise lesteen look	



*1zusätzliches Seitenaufdopplungsdekor
(nicht als Korpusdekor möglich)
*2only washbasin plate colour
*3only washbasin plate colour
*4only washbasin plate colour
*5only washbasin plate colour
*6only washbasin plate colour
*7only washbasin plate colour
*8only washbasin plate colour
*9only washbasin plate colour
*10only washbasin plate colour
*11only washbasin plate colour
*12only washbasin plate colour
*13only washbasin plate colour
*14only washbasin plate colour
*15only washbasin plate colour
*16only washbasin plate colour
*17only washbasin plate colour
*18only washbasin plate colour
*19only washbasin plate colour
*20only washbasin plate colour
*21only washbasin plate colour
*22only washbasin plate colour
*23only washbasin plate colour
*24only washbasin plate colour
*25only washbasin plate colour
*26only washbasin plate colour
*27only washbasin plate colour
*28only washbasin plate colour
*29only washbasin plate colour
*30only washbasin plate colour
*31only washbasin plate colour
*32only washbasin plate colour
*33only washbasin plate colour
*34only washbasin plate colour
*35only washbasin plate colour
*36only washbasin plate colour
*37only washbasin plate colour
*38only washbasin plate colour
*39only washbasin plate colour
*40only washbasin plate colour
*41only washbasin plate colour
*42only washbasin plate colour
*43only washbasin plate colour
*44only washbasin plate colour
*45only washbasin plate colour
*46only washbasin plate colour
*47only washbasin plate colour
*48only washbasin plate colour
*49only washbasin plate colour
*50only washbasin plate colour
*51only washbasin plate colour
*52only washbasin plate colour
*53only washbasin plate colour
*54only washbasin plate colour
*55only washbasin plate colour
*56only washbasin plate colour
*57only washbasin plate colour
*58only washbasin plate colour
*59only washbasin plate colour
*60only washbasin plate colour
*61only washbasin plate colour
*62only washbasin plate colour
*63only washbasin plate colour
*64only washbasin plate colour
*65only washbasin plate colour
*66only washbasin plate colour
*67only washbasin plate colour
*68only washbasin plate colour
*69only washbasin plate colour
*70only washbasin plate colour
*71only washbasin plate colour
*72only washbasin plate colour
*73only washbasin plate colour
*74only washbasin plate colour
*75only washbasin plate colour
*76only washbasin plate colour
*77only washbasin plate colour
*78only washbasin plate colour
*79only washbasin plate colour
*80only washbasin plate colour
*81only washbasin plate colour
*82only washbasin plate colour
*83only washbasin plate colour
*84only washbasin plate colour
*85only washbasin plate colour
*86only washbasin plate colour
*87only washbasin plate colour
*88only washbasin plate colour
*89only washbasin plate colour
*90only washbasin plate colour
*91only washbasin plate colour
*92only washbasin plate colour
*93only washbasin plate colour
*94only washbasin plate colour
*95only washbasin plate colour
*96only washbasin plate colour
*97only washbasin plate colour
*98only washbasin plate colour
*99only washbasin plate colour
*100only washbasin plate colour



Planungsbeispiele
Planning examples | Exemples de composition | Sets

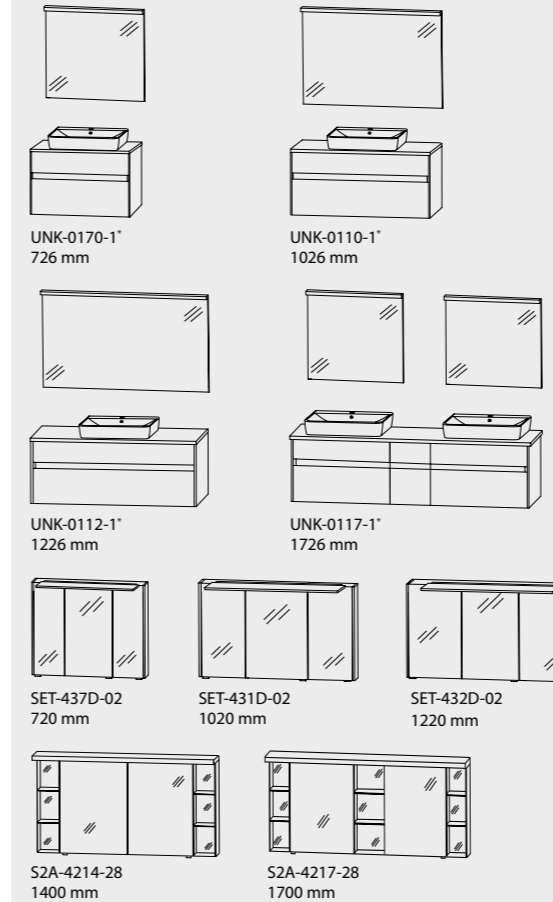

* auch mit LED-Beleuchtung erhältlich
* also available with LED lighting
* aussi disponible avec éclairage LED
* ook mogelijk met LED verlichting

Abbildungen mit „Ideal Standard CONNECT AIR“ Waschtisch.
Technical drawing with "Ideal Standard CONNECT AIR" washbasin.
Les exemples de composition avec vasque à poser «Ideal Standard CONNECT AIR».
Afgebeeld is met "Ideal Standard CONNECT AIR" wastafel.

Ergänzungsschränke | Additional cabinets | Meubles complémentaires | Losse kasten

Hochschränke | tall units | colonnes | hoge kasten

Mittelschränke | central units | armoires moyennes | middenkasten

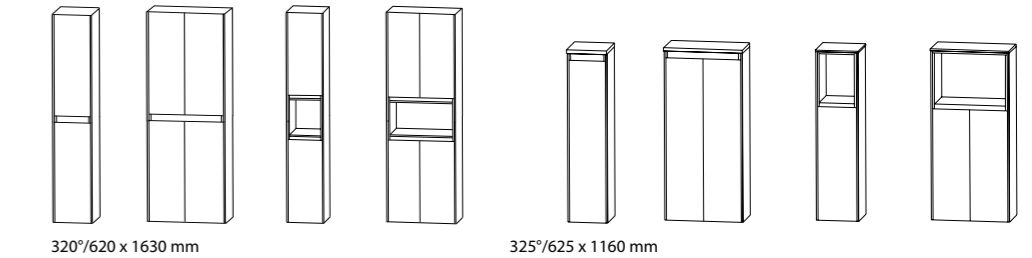

Highboards | highboards | highboards | highboards

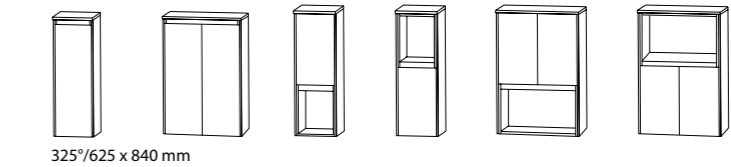

Ober-/Unterschränke | wall/base units | éléments suspendus/bas | boven-/onderkasten

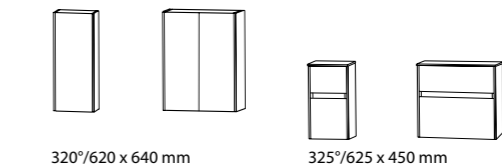

Breite x Höhe in mm
Width x height in mm
Largeur x hauteur in mm
Breedte x hoogte in mm

° Schränke auch in 420 / 425 mm Breite erhältlich.
° Cabinets also available with a width of 420 / 425 mm.
° Les armoires sont également disponibles avec une largeur de 420 / 425 mm.
° Kasten ook verkrijgbaar in 420 / 425 mm breedte.

Abbildungen grifflos, auch mit Griffleiste möglich.
Technical drawings handleless, also available with strip-handle.
Les exemples de composition sans poignée possible avec poignée.
Afbeeldingen zijn greeploos, met greeplijst zijn ook mogelijk.

– Auszug aus dem Typenplan
– Die Artikelnummern der Ergänzungsschränke entnehmen Sie aus den Typenlisten.
– Türen · Auszüge · Schubkästen mit Dämpfung

– Extrait du plan type
– Les références des meubles complémentaires sont présentes dans notre liste d'articles.
– Portes · tiroirs · coulissants avec amortisseur

– Part numbers of the available options
– Please consult the full range available for the article numbers of the add-on cabinets.
– Doors · pull out units · drawers with buffered closing

– Getoonde kasten zijn een selectie uit de kast mogelijkheden
– De bestelcodes van de losse kasten kunt vindt u bij de losse elementen.
– Deuren en lades met softclose



purefaction

Geschwungene und ansprechende Formen mit einzigartiger Funktionalität
 Curved and appealing shapes with unique functionality
 Des formes courbes et attractives alliées à une fonctionnalité unique
 Moderne rondingen met unieke functionaliteit





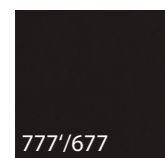
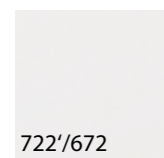
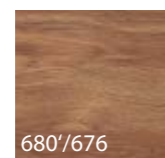
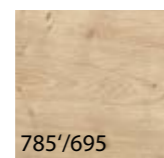
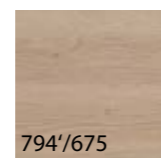

Frontdekore | Front finishes | Façades | Front kleuren

 777/677	 722/672	 680/676	 785/695	 794/675
Cosmos Grey matt cosmos grey matt cosmos grey mat cosmos grey mat	Polarweiß hgl. polarwhite hgl. blanc polaire haute brillance hoogglans wit	Charleston Eiche charleston oak chêne Charleston charleston eiken	Eiche Natur Nachbildung natural oak effect imitation chêne naturel eiken naturel folie	Eiche Sand sand oak chêne sable zand eiken

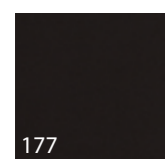
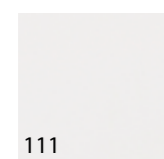
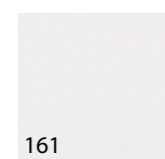
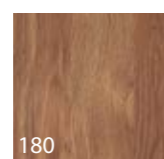
Korpusdekore | Carcass colours | Corps de meuble | Corpus kleuren

 177	 111	 161	 180	 185	 194
Cosmos Grey matt cosmos grey matt cosmos grey mat cosmos grey mat	Weiß matt white matt blanc mat wit mat	Weiß hgl. white hgl. blanc haute brillance hoogglans wit	Charleston Eiche charleston oak chêne Charleston charleston eiken	Eiche Natur Nachbildung natural oak effect imitation chêne naturel eiken naturel folie	Eiche Sand sand oak chêne sable zand eiken



grifflos mit Griffmulde
handleless with recessed grip
sans poignée avec prise de main en creux
grieploos met grieplijstfresing in het front



Nr. 329
Griffleiste chrom
strip handle chrome
profilé poignée chrome
grieplijst chroom



Nr. 339
Griffleiste chrom
strip handle chrome
profilé poignée chrome
grieplijst chroom





Nr. 350
Stangengriff chrom
handle chrome
poignée barre chrome
stangengriep chroom



Nr. 320
Stangengriff chrom
handle chrome
poignée barre chrome
stangengriep chroom

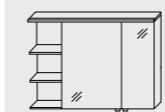

Planungsbeispiele Planning examples | Exemples de composition | Sets

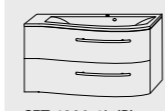
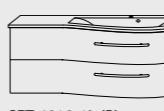
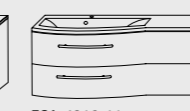
 SET-4290-1L (R) SET-P229-L (R) 912 mm	 SET-4212-1L (R) SET-P222-R (L) 1212 mm	 FSA-4312-11 SET-P222-R (L) 1212 mm
 SET-4290-1R (L) SET-P209-R (L) 912 mm	 SET-4212-1R (L) SET-P212-R (L) 1212 mm	 FSA-4312-11 SET-P212-L (R) 1212 mm

* auch mit LED-Beleuchtung erhältlich
* also available with LED lighting
* aussi disponible avec éclairage LED
* ook mogelijk met LED verlichting

Ergänzungsschränke | Additional cabinets | Meubles complémentaires | Losse kasten

Hochschränke | tall units | colonnes | hoge kasten

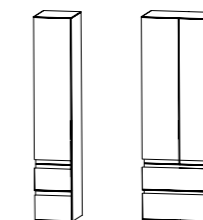

300°/600 x 1600 mm

Mittelschränke | central units | armoires moyennes | middenkasten

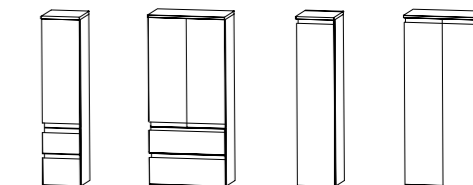

300°/600 x 1136 mm

Highboards | highboards | highboards | highboards

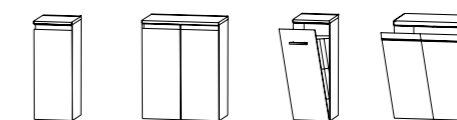

300°/600 x 656 mm

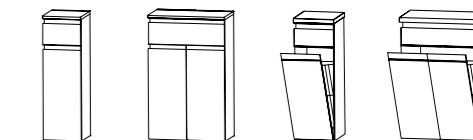

300°/600 x 816 mm

Ober-/Unterschränke | wall/base units | éléments suspendus/bas | boven-/onderkasten

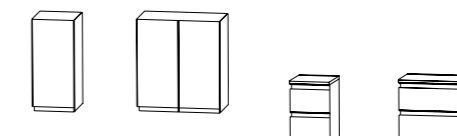

300°/600 x 640 mm



300°/600 x 496 mm

Breite x Höhe in mm
Width x height in mm
Largeur x hauteur in mm
Breedte x hoogte in mm

° Schränke auch in 400 mm Breite erhältlich.
° Cabinets also available with a width of 400 mm.
° Les armoires sont également disponibles avec une largeur de 400 mm.
° Kasten ook verkrijgbaar in 400 mm breedte.

Abbildungen in grifflos, auch mit Griff möglich.
Technical drawings handleless, also available with handle.
Les exemples de composition sans poignées également possible avec poignées.
Afbeeldingen zijn grieploos, met grieplijst zijn ook mogelijk.

- Auszug aus dem Typenplan
- Die Artikelnummern der Ergänzungsschränke entnehmen Sie aus den Typenlisten.
- Türen · Auszüge · Schubkästen mit Dämpfung

- Extrait du plan type
- Les références des meubles complémentaires sont présentes dans notre liste d'articles.
- Portes · tiroirs · coulissants avec amortisseur

- Part numbers of the available options
- Please consult the full range available for the article numbers of the add-on cabinets.
- Doors · pull out units · drawers with buffered closing

- Getoonde kasten zijn een selectie uit de kast mogelijkheden
- De bestelcodes van de losse kasten kunt u vinden bij de losse elementen.
- Deuren en lades met softclose







quada

Viel Stauraum hinter glänzendem Auftritt
 Plenty of storage space behind brilliant appearance
 De grands espaces de rangement au-delà de l'esthétique
 Veel opbergruimte achter een glinsterend optreden

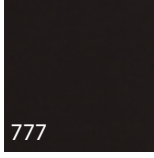
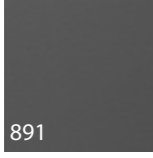

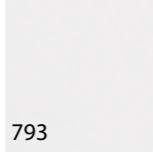
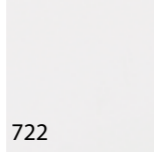
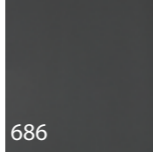
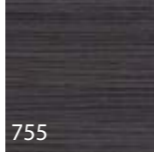
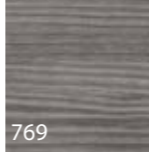
Frontdekore | Front finishes | Façades | Front kleuren

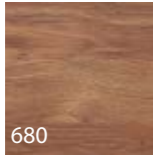
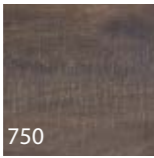
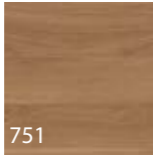
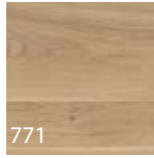
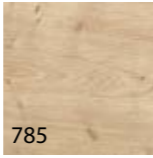
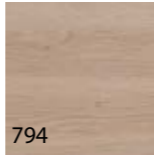
 777 Cosmos Grey matt cosmos grey matt cosmos grey mat cosmos grey mat	 891 Quarzgrau matt quarz grey matt gris quartz mat kwartsgrijs mat	 893 Titangrau matt titanium grey matt titane gris mat titanium grijs mat	 793 Edelweiß matt noble white matt blanc pur mat edelwit mat	 722 Polarweiß hgl. polarwhite hgl. blanc polaire haute brillance hoogglans wit	 686 Anthrazit hgl. anthracite hgl. anthracite haute brillance hoogglans antraciet	 755 Hacienda Schwarz hacienda black noir exotique hacienda zwart	 769 Hacienda Grau hacienda grey gris exotique hacienda grijs
 670 Halifax Eiche halifax oak chêne Halifax halifax eiken	 680 Charleston Eiche charleston oak chêne Charleston charleston eiken	 750 Cardiff Eiche cardiff oak chêne Cardiff cardiff eiken	 751 Cuneo Eiche Braun cuneo oak brown Cuneo imitation chêne marron cuneo eiken bruin	 771 Cuneo Eiche Natural cuneo oak natural Cuneo imitation chêne naturel cuneo eiken naturel	 785 Eiche Natur Nachbildung natural oak effect imitation chêne naturel eiken naturel folie	 794 Eiche Sand sand oak chêne sable zand eiken	

Korpusdekore | Carcass colours | Corps de meuble | Corpus kleuren

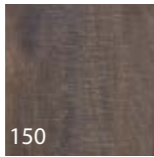
 177 Cosmos Grey matt cosmos grey matt cosmos grey mat cosmos grey mat	 191 Quarzgrau matt quarz grey matt gris quartz mat kwartsgrijs mat	 193 Titangrau matt titanium grey matt titane gris mat titanium grijs mat	 111 Weiß matt white matt blanc mat wit mat	 161 Weiß hgl. white hgl. blanc haute brillance hoogglans wit	 121 Anthrazit hgl. anthracite hgl. anthracite haute brillance hoogglans antraciet	 155 Hacienda Schwarz hacienda black noir exotique hacienda zwart	 169 Hacienda Grau hacienda grey gris exotique hacienda grijs
 170 Halifax Eiche halifax oak chêne Halifax halifax eiken	 180 Charleston Eiche charleston oak chêne Charleston charleston eiken	 150 Cardiff Eiche cardiff oak chêne Cardiff cardiff eiken	 151 Cuneo Eiche Braun cuneo oak brown Cuneo imitation chêne marron cuneo eiken bruin	 171 Cuneo Eiche Natural cuneo oak natural Cuneo imitation chêne naturel cuneo eiken naturel	 185 Eiche Natur Nachbildung natural oak effect imitation chêne naturel eiken naturel folie	 194 Eiche Sand sand oak chêne sable zand eiken	

Planungsbeispiele
Planning examples | Exemples de composition | Sets

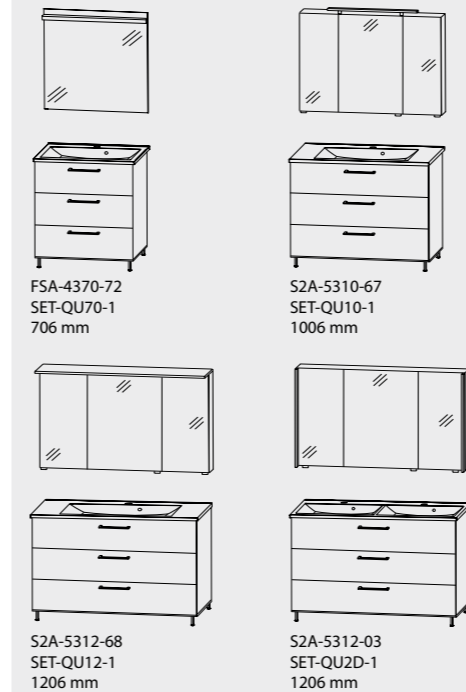

FSA-4370-72
SET-QU70-1
706 mm

S2A-5310-67
SET-QU10-1
1006 mm

S2A-5312-68
SET-QU12-1
1206 mm

S2A-5312-03
SET-QU2D-1
1206 mm

Abbildungen mit Mineralguss-Waschtisch, auch in Keramik erhältlich.
Technical drawing with cast mineral washbasin, also available in ceramic.
Les exemples de compositions avec plan vasque en matériau de synthèse sont également disponible en céramique.
Afbeeldingen zijn met minerale wastafels, keramische wastafels zijn ook mogelijk.



Nr. 335
Stangengriff schwarz
handle black
poignée barre noir
stangengreep zwart

Nr. 321
Stangengriff chrom
handle chrome
poignée barre chrome
stangengreep chrom

Ergänzungsschränke | Additional cabinets | Meubles complémentaires | Losse kasten

Hochschränke | tall units | colonnes | hoge kasten

Mittelschränke | central units | armoires moyennes | middenkasten

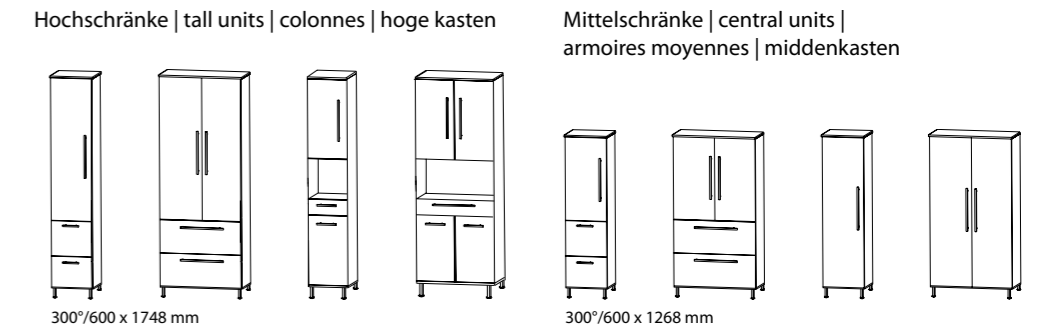

300°/600 x 1748 mm

300°/600 x 1268 mm

Highboards | highboards | highboards | highboards

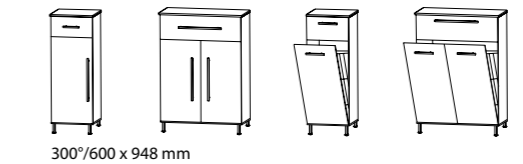

300°/600 x 948 mm

Oberschränke | wall units | éléments suspendus | bovenkasten

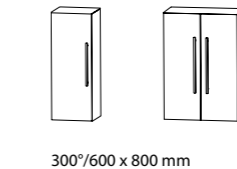

300°/600 x 800 mm

Breite x Höhe in mm
Width x height in mm
Largeur x hauteur in mm
Breedte x hoogte in mm

Höhenangabe inklusive Zierfüße
Height indication inclusive decoration feet
Hauteur spécifiée comprend les pieds déco
Hoogte aangave inclusief siervoet

- ° Schränke auch in 400 mm Breite erhältlich.
- ° Cabinets also available with a width of 400 mm.
- ° Les armoires sont également disponibles avec une largeur de 400 mm.
- ° Kasten ook verkrijgbaar in 400 mm breedte.

- Auszug aus dem Typenplan
- Die Artikelnummern der Ergänzungsschränke entnehmen Sie aus den Typenlisten.
- Türen · Auszüge · Schubkästen mit Dämpfung
- Part numbers of the available options
- Please consult the full range available for the article numbers of the add-on cabinets.
- Doors · pull out units · drawers with buffered closing

- Extrait du plan type
- Les références des meubles complémentaires sont présentes dans notre liste d'articles.
- Portes · tiroirs · coulissants avec amortisseur
- Getoonde kasten zijn een selectie uit de kast mogelijkheden
- De bestelcodes van de losse kasten kunt vindt u bij de losse elementen.
- Deuren en lades met softclose



ace

Klare Kante gemischt mit Eleganz
 Cutting edge mixed with elegance
 Des bords francs mariés à l'élégance
 Strakke vorm gecombineerd met elegantie



Frontdekore | Front finishes | Façades | Front kleuren





 <p>677</p> <p>Cosmos Grey matt Cosmos grey matt Cosmos grey mat Cosmos grey mat</p>	 <p>672</p> <p>Polarweiß hgl. polarwhite hgl. blanc polaire haute brillance hoogglans wit</p>	 <p>671</p> <p>Anthrazit hgl. anthracite hgl. anthracite haute brillance hoogglans antraciet</p>
 <p>675</p> <p>Eiche Sand sand oak chêne sable zand eiken</p>	 <p>695</p> <p>Eiche Natur Nachbildung natural oak effect imitation chêne naturel eiken naturel folie</p>	

Korpusdekore | Carcass colours | Corps de meuble | Corpus kleuren

 <p>177</p> <p>Cosmos Grey matt Cosmos grey matt Cosmos grey mat Cosmos grey mat</p>	 <p>111</p> <p>Weiß matt white matt blanc mat wit mat</p>	 <p>161</p> <p>Weiß hgl. white hgl. blanc haute brillance hoogglans wit</p>
 <p>121</p> <p>Anthrazit hgl. anthracite hgl. anthracite haute brillance hoogglans antraciet</p>	 <p>185</p> <p>Eiche Natur Nachbildung natural oak effect imitation chêne naturel eiken naturel folie</p>	 <p>194</p> <p>Eiche Sand sand oak chêne sable zand eiken</p>



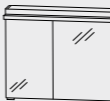
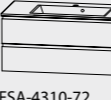
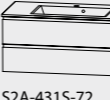

Planungsbeispiele
Planning examples | Exemples de composition | Sets

 	 
<p>FSA-4370-72 SET-7012-1* 720 mm</p>	<p>S2A-4375-72 SET-7012-1* 720 mm</p>
 	 
<p>FSA-4312-72 SET-1212-1* 1220 mm</p>	<p>S2A-4325-72 SET-122D-1* 1220 mm</p>

* auch mit LED-Beleuchtung erhältlich * also available with LED lighting
* aussi disponible avec éclairage LED * ook mogelijk met LED verlichting

Abbildungen mit Mineralguss-Waschtisch, auch in Glas oder Keramik erhältlich.
Technical drawing with cast mineral washbasin, also available in glass or ceramic.
Les exemples de composition avec plan vasque en matériau de synthèse sont également disponible en verre ou en céramique.
Afbeeldingen zijn met minerale wastafels, glazen en keramische wastafels zijn ook mogelijk.

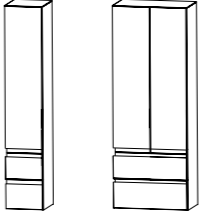
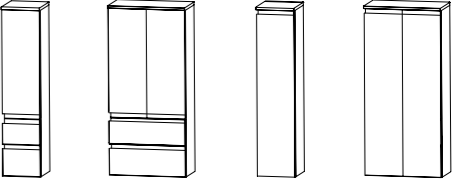
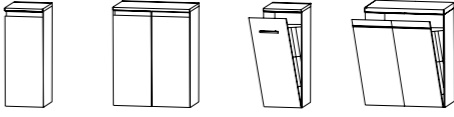
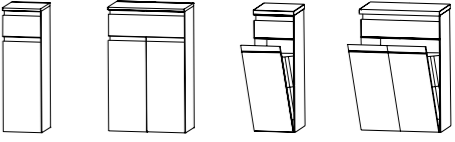
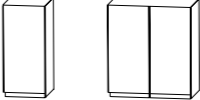
Ergänzungsschränke | Additional cabinets | Meubles complémentaires | Losse kasten

<p>Hochschränke tall units colonnes hoge kasten</p>  <p>300°/600 x 1600 mm</p>	<p>Mittelschränke central units armoires moyennes middenkasten</p>  <p>300°/600 x 1136 mm</p>
<p>Highboards highboards highboards highboards</p>  <p>300°/600 x 656 mm</p>	 <p>300°/600 x 816 mm</p>
<p>Ober-/Unterschränke wall/base units éléments suspendus/bas boven-/onderkasten</p>  <p>300°/600 x 640 mm</p>	 <p>300°/600 x 496 mm</p>

° Schränke auch in 400 mm Breite erhältlich.
° Cabinets also available with a width of 400 mm.
° Les armoires sont également disponibles avec une largeur de 400 mm.
° Kasten ook verkrijgbaar in 400 mm breedte.

- | | |
|--|---|
| <ul style="list-style-type: none"> - Auszug aus dem Typenplan - Die Artikelnummern der Ergänzungsschränke entnehmen Sie aus den Typenlisten. - Türen · Auszüge · Schubkästen mit Dämpfung | <ul style="list-style-type: none"> - Extrait du plan type - Les références des meubles complémentaires sont présentes dans notre liste d'articles. - Portes · tiroirs · coulissants avec amortisseur |
| <ul style="list-style-type: none"> - Part numbers of the available options - Please consult the full range available for the article numbers of the add-on cabinets. - Doors · pull out units · drawers with buffered closing | <ul style="list-style-type: none"> - Getoonde kasten zijn een selectie uit de kast mogelijkheden - De bestelcodes van de losse kasten kunt vindt u bij de losse elementen. - Deuren en lades met softclose |





vuelta

Perfekte Rundungen mit raffinierten Details
 Perfect curves with refined details
 Des rondeurs parfaites dotées de détails raffinés
 Perfekte rondingen met geraffineerde details



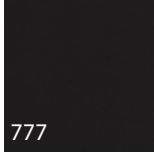
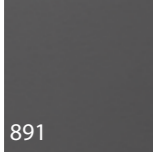

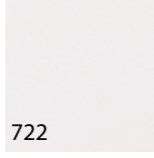
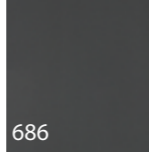

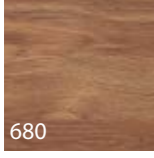
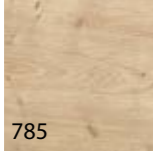
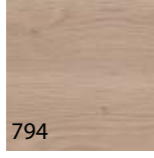
Frontdekore | Front finishes | Façades | Front kleuren

 777	 891	 893	 793	 722	 686
Cosmos Grey matt cosmos grey matt cosmos grey mat cosmos grey mat	Quarzgrau matt quarz grey matt gris quartz mat kwartsgrijs mat	Titangrau matt titanium grey matt titane gris mat titanium grijs mat	Edelweiß matt noble white matt blanc pur mat edelwit mat	Polarweiß hgl. polarwhite hgl. blanc polaire haute brillance hoogglans wit	Anthrazit hgl. anthracite hgl. anthracite haute brillance hoogglans antraciet

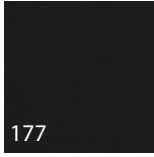
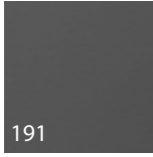
 680	 785	 794
Charleston Eiche charleston oak chêne Charleston charleston eiken	Eiche Natur Nachbildung natural oak effect imitation chêne naturel eiken naturel folie	Eiche Sand sand oak chêne sable zand eiken

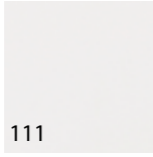
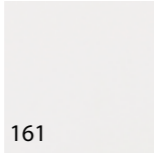
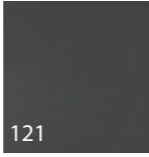
Korpusdekore | Carcass colours | Corps de meuble | Corpus kleuren

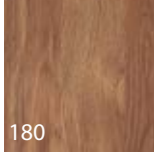
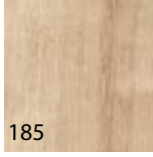
 177	 191	 193	 111	 161	 121
Cosmos Grey matt cosmos grey matt cosmos grey mat cosmos grey mat	Quarzgrau matt quarz grey matt gris quartz mat kwartsgrijs mat	Titangrau matt titanium grey matt titane gris mat titanium grijs mat	Weiß matt white matt blanc mat wit mat	Weiß hgl. white hgl. blanc haute brillante hoogglans wit	Anthrazit hgl. anthracite hgl. anthracite haute brillance hoogglans antraciet

 180	 185	 194
Charleston Eiche charleston oak chêne Charleston charleston eiken	Eiche Natur Nachbildung natural oak effect imitation chêne naturel eiken naturel folie	Eiche Sand sand oak chêne sable zand eiken













Nr. 350
Stangengriff schwarz
handle black
poignée barre noir
stangengreep zwart

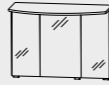
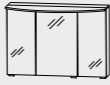





Nr. 320
Stangengriff chrom
handle chrome
poignée barre chrome
stangengreep chrom

Planungsbeispiele
Planning examples | Exemples de composition | Sets

 S2A-4375-1* SET-VU70-1** 712 mm	 S2A-4375-2* SET-VU70-1** 712 mm	 S2A-4375-3* SET-VU70-1** 712 mm
 S2A-4395-1* SET-VU90-1** 912 mm	 S2A-4395-2* SET-VU90-1** 912 mm	 S2A-4395-3* SET-VU90-1** 912 mm
 S2A-4325-1* SET-VU12-1** 1212 mm	 S2A-4325-2* SET-VU12-1** 1212 mm	 S2A-4325-3* SET-VU12-1** 1212 mm
 S2A-4345-1* SET-VU14-1** 1412 mm	 S2A-4345-2* SET-VU14-1** 1412 mm	 S2A-4345-3* SET-VU4D-1** 1412 mm

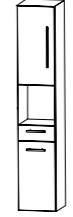
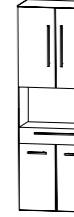
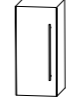
Ergänzungsschränke | Additional cabinets | Meubles complémentaires | Losse kasten

 300°/600 x 1600 mm	 300°/600 x 1296 mm	 300°/600 x 656 mm	 300°/600 x 816 mm	 300°/600 x 640 mm	 300°/600 x 496 mm
---	---	--	--	--	--

Breite x Höhe in mm
Width x height in mm
Largeur x hauteur in mm
Breedte x hoogte in mm

° Schränke auch in 400 mm Breite erhältlich.
° Cabinets also available with a width of 400 mm.
° Les armoires sont également disponibles avec une largeur de 400 mm.
° Kasten ook verkrijgbaar in 400 mm breedte.

i * auch mit Facettenschliff erhältlich
* also available with facet cut
* aussi disponible avec encadrement biseauté
* ook mogelijk met facet rand

** auch mit LED-Beleuchtung erhältlich
** also available with LED lighting
** aussi disponible avec éclairage LED
** ook mogelijk met LED verlichting

– Auszug aus dem Typenplan
– Die Artikelnummern der Ergänzungsschränke entnehmen Sie aus den Typenlisten.
– Türen · Auszüge · Schubkästen mit Dämpfung
– Part numbers of the available options
– Please consult the full range available for the article numbers of the add-on cabinets.
– Doors · pull out units · drawers with buffered closing

– Extrait du plan type
– Les références des meubles complémentaires sont présentes dans notre liste d'articles.
– Portes · tiroirs · coulissants avec amortisseur
– Getoonde kasten zijn een selectie uit de kast mogelijkheden
– De bestelcodes van de losse kasten kunt u bij de losse elementen.
– Deuren en lades met softclose





linea

Ein faszinierender Mix aus Kurven und Ecken
 A fascinating mix of curves and corners
 Un mélange fascinant de courbes et d'angles
 Een fascinerende combinatie van rond en strak



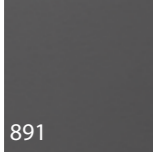

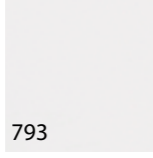
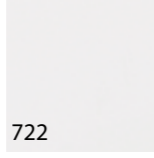
Frontdekore | Front finishes | Façades | Front kleuren

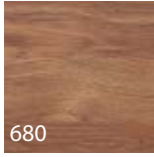
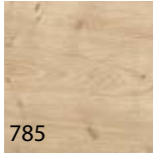
 <p>777</p> <p>Cosmos Grey matt cosmos grey matt cosmos grey mat cosmos grey mat</p>	 <p>891</p> <p>Quarzgrau matt quarz grey matt gris quartz mat kwartsgrijs mat</p>	 <p>893</p> <p>Titangrau matt titanium grey matt titane gris mat titanium grijs mat</p>	 <p>793</p> <p>Edelweiß matt noble white matt blanc pur mat edelwit mat</p>	 <p>722</p> <p>Polarweiß hgl. polarwhite hgl. blanc polaire haute brillance hoogglans wit</p>	 <p>686</p> <p>Anthrazit hgl. anthracite hgl. anthracite haute brillance hoogglans antraciet</p>
--	--	--	--	--	--

 <p>680</p> <p>Charleston Eiche charleston oak chêne Charleston charleston eiken</p>	 <p>785</p> <p>Eiche Natur Nachbildung natural oak effect imitation chêne naturel eiken naturel folie</p>
--	--

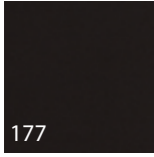
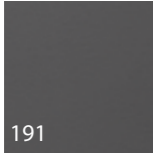
Korpusdekore | Carcass colours | Corps de meuble | Corpus kleuren

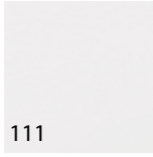
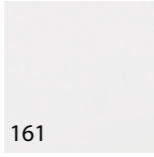
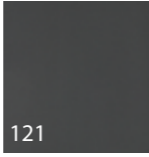
 <p>177</p> <p>Cosmos Grey matt cosmos grey matt cosmos grey mat cosmos grey mat</p>	 <p>191</p> <p>Quarzgrau matt quarz grey matt gris quartz mat kwartsgrijs mat</p>	 <p>193</p> <p>Titangrau matt titanium grey matt titane gris mat titanium grijs mat</p>	 <p>111</p> <p>Weiß matt white matt blanc mat wit mat</p>	 <p>161</p> <p>Weiß hgl. white hgl. blanc haute brillance hoogglans wit</p>	 <p>121</p> <p>Anthrazit hgl. anthracite hgl. anthracite haute brillance hoogglans antraciet</p>
---	---	---	---	---	---

 <p>180</p> <p>Charleston Eiche charleston oak chêne Charleston charleston eiken</p>	 <p>185</p> <p>Eiche Natur Nachbildung natural oak effect imitation chêne naturel eiken naturel folie</p>
--	--







Nr. 350
Stangengriff schwarz
handle black
poignée barre noir
stangengreep zwart

Nr. 320
Stangengriff chrom
handle chrome
poignée barre chrome
stangengreep chrom

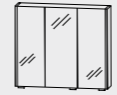

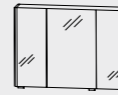
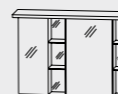
Planungsbeispiele
Planning examples | Exemples de composition | Sets

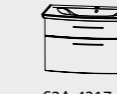
 <p>S2A-4270-S1 L (R) SET-LN70-1* 712 mm</p>	 <p>S2A-4370-79 SET-LN70-1* 712 mm</p>	
 <p>S2A-42R1-S1 SET-LN10-1 R* 1012 mm</p>	 <p>S2A-42L1-S1 SET-LN10-1 L* 1012 mm</p>	 <p>S2A-4310-79 SET-LN10-1 L* 1012 mm</p>
 <p>S2A-4213-S1 SET-LN13-1* 1312 mm</p>	 <p>S2A-4313-79 SET-LN13-1* 1312 mm</p>	
 <p>S2A-4217-S1 SET-LN17-1* 1712 mm</p>	 <p>S2A-4317-79 SET-LN17-1* 1712 mm</p>	

Ergänzungsschränke | Additional cabinets | Meubles complémentaires | Losse kasten

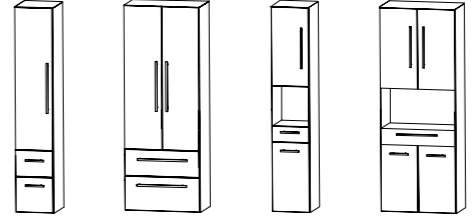
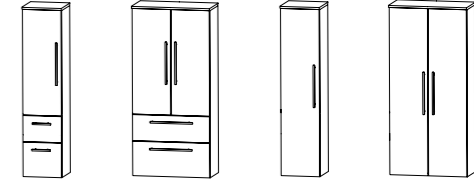
<p>Hochschränke tall units colonnes hoge kasten</p>  <p>300°/600 x 1600 mm</p>	<p>Mittelschränke central units armoires moyennes middenkasten</p>  <p>300°/600 x 1296 mm</p>
---	--

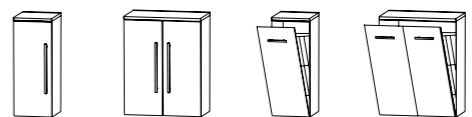
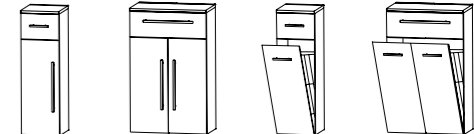
<p>Highboards highboards highboards highboards</p>  <p>300°/600 x 656 mm</p>	 <p>300°/600 x 816 mm</p>
---	--

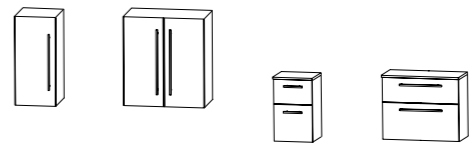
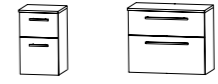
<p>Ober-/Unterschränke wall/base units éléments suspendus/bas boven-/onderkasten</p>  <p>300°/600 x 640 mm</p>	 <p>300°/600 x 496 mm</p>	<p>Breite x Höhe in mm Width x height in mm Largeur x hauteur in mm Breedte x hoogte in mm</p>
--	---	--

- ° Schränke auch in 400 mm Breite erhältlich.
- ° Cabinets also available with a width of 400 mm.
- ° Les armoires sont également disponibles avec une largeur de 400 mm.
- ° Kasten ook verkrijgbaar in 400 mm breedte.

i * auch mit LED-Beleuchtung erhältlich
* also available with LED lighting
* aussi disponible avec éclairage LED
* ook mogelijk met LED verlichting

- Auszug aus dem Typenplan
- Die Artikelnummern der Ergänzungsschränke entnehmen Sie aus den Typenlisten.
- Türen · Auszüge · Schubkästen mit Dämpfung
- Part numbers of the available options
- Please consult the full range available for the article numbers of the add-on cabinets.
- Doors · pull out units · drawers with buffered closing

- Extrait du plan type
- Les références des meubles complémentaires sont présentes dans notre liste d'articles.
- Portes · tiroirs · coulissants avec amortisseur
- Getoonde kasten zijn een selectie uit de kast mogelijkheden
- De bestelcodes van de losse kasten kunt vindt u bij de losse elementen.
- Deuren en lades met softclose



fresh

Geradliniger Klassiker mit vielseitigen Kombinationsmöglichkeiten
 Straightforward classic with versatile combination possibilities
 Un classique simple offrant de nombreuses possibilités de combinaisons
 Strakke vorm met veel kombinatiemogelijkheden







Nr. 294
Stangengriff chrom
handle chrome
poignée barre chrome
stangengreep chrom



Nr. 321
Stangengriff chrom
handle chrome
poignée barre chrome
stangengreep chrom

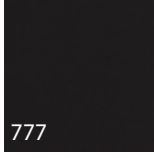
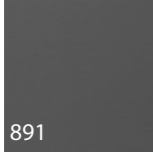

Frontdekore | Front finishes | Façades | Front kleuren

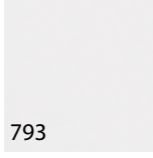
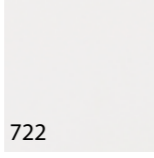
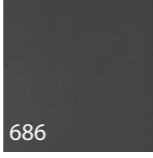
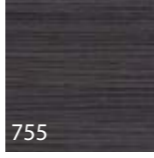
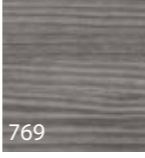
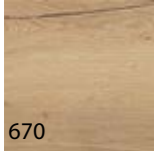
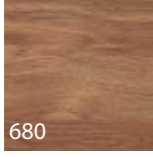
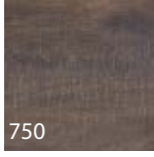
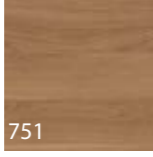
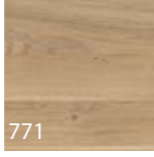
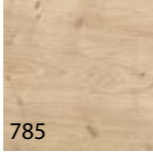
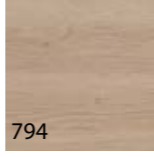
 777 Cosmos Grey matt cosmos grey matt cosmos grey mat cosmos grey mat	 891 Quarzgrau matt quarz grey matt gris quartz mat kwartsgrijs mat	 893 Titangrau matt titanium grey matt titane gris mat titanium grijs mat	 793 Edelweiß matt noble white matt blanc pur mat edelwit mat	 722 Polarweiß hgl. polarwhite hgl. blanc polaire haute brillance hoogglans wit	 686 Anthrazit hgl. anthracite hgl. anthracite haute brillance hoogglans antraciet	 755 Hacienda Schwarz hacienda black noir exotique hacienda zwart	 769 Hacienda Grau hacienda grey gris exotique hacienda grijs
 670 Halifax Eiche halifax oak chêne Halifax halifax eiken	 680 Charleston Eiche charleston oak chêne Charleston charleston eiken	 750 Cardiff Eiche cardiff oak chêne Cardiff cardiff eiken	 751 Cuneo Eiche Braun cuneo oak brown Cuneo imitation chêne marron cuneo eiken bruin	 771 Cuneo Eiche Natural cuneo oak natural Cuneo imitation chêne naturel cuneo eiken naturel	 785 Eiche Natur Nachbildung natural oak effect imitation chêne naturel eiken naturel folie	 794 Eiche Sand sand oak chêne sable zand eiken	

Korpusdekore | Carcass colours | Corps de meuble | Corpus kleuren

 177 Cosmos Grey matt cosmos grey matt cosmos grey mat cosmos grey mat	 191 Quarzgrau matt quarz grey matt gris quartz mat kwartsgrijs mat	 193 Titangrau matt titanium grey matt titane gris mat titanium grijs mat	 111 Weiß matt white matt blanc mat wit mat	 161 Weiß hgl. white hgl. blanc haute brillance hoogglans wit	 121 Anthrazit hgl. anthracite hgl. anthracite haute brillance hoogglans antraciet	 155 Hacienda Schwarz hacienda black noir exotique hacienda zwart	 169 Hacienda Grau hacienda grey gris exotique hacienda grijs
 170 Halifax Eiche halifax oak chêne Halifax halifax eiken	 180 Charleston Eiche charleston oak chêne Charleston charleston eiken	 150 Cardiff Eiche cardiff oak chêne Cardiff cardiff eiken	 151 Cuneo Eiche Braun cuneo oak brown Cuneo imitation chêne marron cuneo eiken bruin	 171 Cuneo Eiche Natural cuneo oak natural Cuneo imitation chêne naturel cuneo eiken naturel	 185 Eiche Natur Nachbildung natural oak effect imitation chêne naturel eiken naturel folie	 194 Eiche Sand sand oak chêne sable zand eiken	

Planungsbeispiele
Planning examples | Exemples de composition | Sets

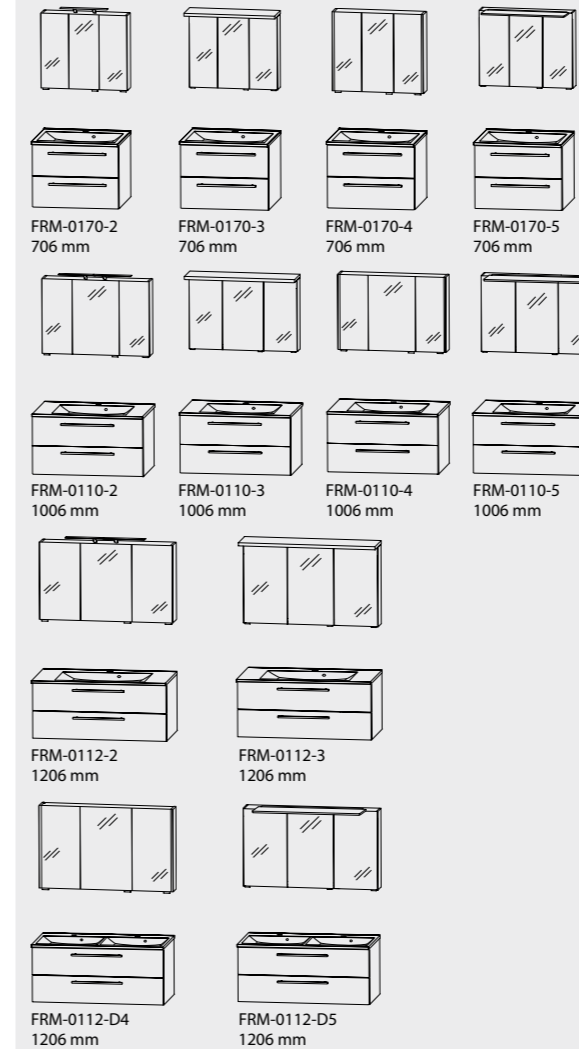

FRM-0170-2 706 mm

FRM-0170-3 706 mm

FRM-0170-4 706 mm

FRM-0170-5 706 mm

FRM-0110-2 1006 mm

FRM-0110-3 1006 mm

FRM-0110-4 1006 mm

FRM-0110-5 1006 mm

FRM-0112-2 1206 mm

FRM-0112-3 1206 mm

FRM-0112-D4 1206 mm

FRM-0112-D5 1206 mm

Alternativ Flächenspiegel in 700 / 1000 / 1200 mm Breite erhältlich.
Alternative mirrors available in widths 700 / 1000 / 1200 mm.
Alternative: miroir disponible en 700 / 1000 / 1200 mm de largeur
Alternatief zijn spiegels in 700 / 1000 / 1200 breedte verkrijgbaar.

Ergänzungsschränke | Additional cabinets | Meubles complémentaires | Losse kasten

Hochschränke | tall units | colonnes | hoge kasten

Mittelschränke | central units | armoires moyennes | middenkasten

Highboards | highboards | highboards | highboards

Ober-/Unterschränke | wall/base units | éléments suspendus/bas | boven-/onderkasten

300°/600 x 1600 mm

300°/600 x 1136 mm

300°/600 x 656 mm

300°/600 x 816 mm

300°/600 x 640 mm

300°/600 x 496 mm

Breite x Höhe in mm
Width x height in mm
Largeur x hauteur in mm
Breedte x hoogte in mm

° Schränke auch in 400 mm Breite erhältlich.
° Cabinets also available with a width of 400 mm.
° Les armoires sont également disponibles avec une largeur de 400 mm.
° Kasten ook verkrijgbaar in 400 mm breedte.

Abbildungen mit Mineralguss-Waschtisch, auch in Glas oder Keramik erhältlich.
Technical drawing with cast mineral washbasin, also available in glass or ceramic.
Les exemples de composition avec plan vasque en matériau de synthèse sont également disponible en verre ou en céramique.
Afbeeldingen zijn met minerale wastafels, glazen en keramische wastafels zijn ook mogelijk.

- Auszug aus dem Typenplan
- Die Artikelnummern der Ergänzungsschränke entnehmen Sie aus den Typenlisten.
- Türen · Auszüge · Schubkästen mit Dämpfung
- Part numbers of the available options
- Please consult the full range available for the article numbers of the add-on cabinets.
- Doors · pull out units · drawers with buffered closing

- Extrait du plan type
- Les références des meubles complémentaires sont présentes dans notre liste d'articles.
- Portes · tiroirs · coulissants avec amortisseur
- Getoonde kasten zijn een selectie uit de kast mogelijkheden
- De bestelcodes van de losse kasten kunt vindt u bij de losse elementen.
- Deuren en lades met softclose



PROTECTION 1 Keramik-Waschtisch, weiß
ceramic washbasin, white
plan vasque céramique, blanc
keramische wastafel, wit



D.LIGHT Mineralguss-Waschtisch, weiß
cast mineral washbasin, white
plan vasque en matériau de synthèse, blanc
minerale wastafel, wit



UNIQUE „Ideal Standard CONNECT AIR“
Keramik-Aufsatzwaschtisch, weiß
ceramic top-mounted washbasin, white | vasque à poser
céramique, blanc | keramische opzetwastafel, wit



UNIQUE Keramik-Aufsatzwaschtisch „Melbourne“, weiß
ceramic top-mounted washbasin „Melbourne“, white
vasque à poser céramique «Melbourne», blanc
keramische opzetwastafel „Melbourne“, wit



UNIQUE Keramik-Aufsatzwaschtisch „Málaga“, weiß
ceramic top-mounted washbasin „Málaga“, white
vasque à poser céramique «Málaga», blanc
keramische opzetwastafel „Málaga“, wit



PUREFACTION Mineralguss-Waschtisch, weiß
cast mineral washbasin, white
plan vasque en matériau de synthèse, blanc
minerale wastafel, wit



QUADA Mineralguss-Waschtisch, weiß
cast mineral washbasin, white
plan vasque en matériau de synthèse, blanc
minerale wastafel, wit



QUADA Keramik-Waschtisch, weiß
ceramic washbasin, white
plan vasque céramique, blanc
keramische wastafel, wit



ACE Mineralguss-Waschtisch, weiß
cast mineral washbasin, white
plan vasque en matériau de synthèse, blanc
minerale wastafel, wit



ACE Keramik-Waschtisch, weiß
ceramic washbasin, white
plan vasque céramique, blanc
keramische wastafel, wit



ACE Glas-Waschtisch, optiwhite
glass washbasin, optiwhite
plan vasque en verre, optiwhite
glazen wastafel, optiwhite



VUELTA Mineralguss-Waschtisch, weiß
cast mineral washbasin, white
plan vasque en matériau de synthèse, blanc
minerale wastafel, wit



LINEA Mineralguss-Waschtisch, weiß
cast mineral washbasin, white
plan vasque en matériau de synthèse, blanc
minerale wastafel, wit



FRESH Mineralguss-Waschtisch, weiß
cast mineral washbasin, white
plan vasque en matériau de synthèse, blanc
minerale wastafel, wit



FRESH Keramik-Waschtisch, weiß
ceramic washbasin, white
plan vasque céramique, blanc
keramische wastafel, wit



FRESH Glas-Waschtisch, optiwhite
glass washbasin, optiwhite
plan vasque en verre, optiwhite
glazen wastafel, optiwhite