

# Möbel LETZ

*Finden und Wohlfühlen*



## Prospekt

Star Line von puris - Badezimmer Polarweiß

### **Wichtiger Hinweis für Sie als Verbraucher**

Etwaige Hinweise des Herstellers in dieser Produktinformation, die sich auf die Gewährleistung beziehen, haben für Sie keinerlei Bindungswirkung und können von Ihnen ignoriert werden. Ihre gesetzlichen Gewährleistungsrechte als Verbraucher uns gegenüber, als Ihrem Verkäufer, werden dadurch in keiner Weise berührt oder eingeschränkt. Sie können sich wegen aller Mängel jederzeit an uns wenden. Darüber hinaus gehende Herstellergarantien bleiben natürlich unberührt.

Möbel Letz GmbH  
Am Gewerbepark 11  
06895 Zahna-Elster

Tel.: 035383 - 6018 50

Fax.: 035383 - 6018 17



**puris**  
4life

*spirit of bathrooms*



2020/2021

ROUNDS · MODERN LIFE · XPRESSION · 4LANDA · ASPEKT · SLIM LINE · KAO LINE · FINE LINE · ICE LINE · BRILLANT · VARIADO 2.0 · SWING · CRESCENDO · STAR LINE · CLASSIC LINE · COOL LINE





**puris**  
4life



# ROUNDS







**puris**  
4life









**puris**  
4life



# ROUNDS

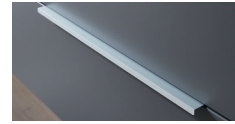

Griffleiste - chrom / alu matt / schwarz matt  
 strip handle - chrome / alu matt / black matt  
 profilé poignée - chrome / alu mat / noir mat  
 greeplijst - chroom / alu mat / zwart mat



Glas-Waschtisch - optiwhite / optiwhite matt / schwarz matt  
 glass washbasin - optiwhite / optiwhite matt / black matt  
 plan vasque en verre - optiwhite / optiwhite mat / noir mat  
 glazen wastafel - optiwhite / optiwhite mat / zwart mat

**STONEPLUS®**

STONEPLUS® Waschtisch, weiß  
 STONEPLUS® washbasin, white  
 STONEPLUS® plan vasque, blanc  
 STONEPLUS® wastafel, wit

➤ „Málaga“ Keramik-Aufsatzwaschtisch, weiß  
 "Málaga" ceramic top-mounted washbasin, white  
 «Málaga» vasque à poser en céramique, blanc  
 "Málaga" keramische opzetwastafel, wit

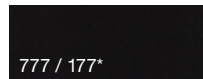

Cosmos grey matt  
 cosmos grey matt  
 cosmos grey mat  
 cosmos grey mat

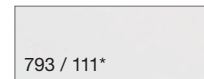

Edelweiß matt / Weiß matt  
 noble white matt / white matt  
 blanc pur mat / blanc mat  
 edelwit mat / wit mat



Polarweiß hgl. / Weiß hgl.  
 polarwhite hgl. / white hgl.  
 blanc polaire haute brillance /  
 blanc haute brillance  
 hoogglans wit



Eiche natur Nachbildung  
 natural oak effect  
 imitation chêne naturel  
 eiken naturel folie

Frontdekore / Korpusdekore  
 Front finishes / Carcass colours  
 Façades / Corps de meuble  
 Front kleuren / Corpus kleuren

\* = Waschtischplattendekore / Abdeckplattendekore  
 \* = washbasin top colours / top cover colours  
 \* = coloris plan de toilette pour vasque à poser /  
 coloris de plateaux de recouvrement  
 \* = wastafelplaat kleuren / afdekkblad kleuren



Hunton Eiche  
 hunton oak  
 chêne Hunton  
 hunton eiken



Halifax Eiche  
 halifax oak  
 chêne Halifax  
 halifax eiken

Hunton Eiche (174) und Halifax Eiche (170) - nur  
 Waschtischplatten- und Abdeckplattendekr.

Hunton oak (174) and halifax oak (170) only  
 washbasin plate and top cover colour.

Chêne Hunton (174) et chêne Halifax (170) seulement colo-  
 ris plan de toilette pour vasque à poser et coloris  
 de plateaux de recouvrement.

Hunton eiken (174) en halifax eiken (170) alleen  
 wastafelplaat en afdekkblad kleur.

Badmöbelkombinationen in 632, 932, 1232 und 1432 mm Breite erhältlich. 1432 mm Breite ausschließlich als Doppelwaschtisch möglich. „Málaga“ Keramik-Aufsatzwaschtisch: 626, 926, 1226 und 1426 mm Breite  
 Bathroom furniture combinations available in widths 632, 932, 1232 and 1432 mm. Width 1432 mm, only as double washbasin. "Málaga" ceramic top-mounted washbasin: width 626, 926, 1226 and 1426 mm  
 Compositions de salle de bains disponibles en largeur de 632, 932, 1232 et 1432 mm. Largeur de 1432 mm seulement comme plan double vasque. «Málaga» vasque à poser en céramique: 626, 926, 1226 et 1426 mm largeur  
 Badkamermeubelcombinaties in 632, 932, 1232 en 1432 mm breed verkrijgbaar. 1432 mm breed alleen als dubbele wastafel mogelijk. "Málaga" keramische opzetwastafel: 626, 926, 1226 en 1426 mm breed



*Kollektion* **MODERN LIFE** *by*  
*Kaja Prinzessin von Hohenzollern*



**puris**  
4life





„Modern Life“ by Maja Prinzessin von Hohenzollern ist eine nachhaltige Design-Line mit klaren Strukturen. Das Konzept verbindet warme Naturtöne mit trendigen Oberflächen. Dadurch entsteht eine wohnliche und ebenso moderne Atmosphäre.

“Modern Life” by Maja Princess of Hohenzollern is a sustainable design with clear features. The concept combines warm natural tones with trendy surfaces. This creates a homely yet equally modern atmosphere.

«Modern Life» ,by Maja Princesse de Hohenzollern, est une ligne de design durable avec des structures claires. Le concept combine des tons chauds de la nature et des surfaces à la mode. Cela crée une atmosphère confortable et tout aussi moderne.

“Modern Life” door Maja Princess of Hohenzollern is een duurzame ontwerplijn met heldere structuren. Het concept combineert warme natuurinten met trendy oppervlakken. Dit zorgt voor een huiselijke en even moderne sfeer.







**puris**  
4life









**puris**  
4life





Push to open  
push to open  
push to open  
push to open



Griffleiste - chrom / alu matt / schwarz matt  
strip handle - chrome / alu matt / black matt  
profilé poignée - chrome / alu mat / noir mat  
grieplijst - chroom / alu mat / zwart mat

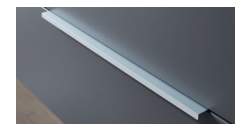

„Ideal Standard CONNECT AIR“  
Keramik-Aufsatzwaschtisch, weiß  
ceramic top-mounted washbasin, white  
vasque à poser en céramique, blanc  
keramische opzetwastafel, wit



„Málaga“ Keramik-Aufsatzwaschtisch, weiß  
"Málaga" ceramic top-mounted washbasin, white  
«Málaga» vasque à poser en céramique, blanc  
"Málaga" keramische opzetwastafel, wit

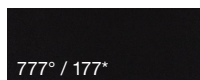

777° / 177°  
Cosmos grey matt  
cosmos grey matt  
cosmos grey mat  
cosmos grey mat



793° / 111°  
Edelweiß matt / Weiß matt  
noble white matt / white matt  
blanc pur mat / blanc mat  
edelwit mat / wit mat



891° / 191°  
Quarzgrau matt  
quarz grey matt  
gris quartz mat  
kwartsgrijs mat

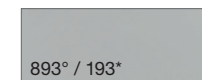

893° / 193°  
Titangrau matt  
titanium grey matt  
titane gris mat  
titanium grijs mat

Frontdekore / Korpusdekore /  
Wandverkleidungsdekore  
Front finishes / Carcass colours /  
Wall covering colours  
Façades / Corps de meuble /  
Coloris de crédence  
Front kleuren / Corpus kleuren /  
Gevelbekleding kleuren

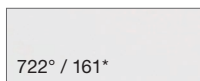

722° / 161°  
Polarweiß hgl. / Weiß hgl.  
polarwhite hgl. / white hgl.  
blanc polaire haute brillance /  
blanc haute brillance  
hooggglans wit



785 / 185°  
Eiche natur Nachbildung  
natural oak effect  
imitation chêne naturel  
eiken naturel folie



670 / 170°  
Halifax Eiche  
halifax oak  
chêne Halifax  
halifax eiken

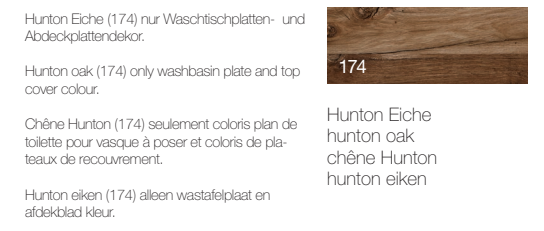

Hunton Eiche (174) nur Waschtischplatten- und  
Abdeckplattendekor.  
Hunton oak (174) only washbasin plate and top  
cover colour.  
Chêne Hunton (174) seulement coloris plan de  
toilette pour vasque à poser et coloris de pla-  
teaux de recouvrement.  
Hunton eiken (174) alleen wastafelplaat en  
afdeklad kleur.



174  
Hunton Eiche  
hunton oak  
chêne Hunton  
hunton eiken



° = Dekorstreifen  
° = accent colours  
° = décor avec mise en relief  
° = accentdecors

\* = Waschtischplatten- / Abdeckplattendekore  
\* = washbasin top colours / top cover colours  
\* = coloris plan de toilette pour vasque à poser / coloris de plateaux de recouvrement  
\* = wastafelplaat kleuren / afdeklad kleuren

Badmöbelkombinationen in 666, 966, 1066, 1266, 1366 und 1566 mm Breite erhältlich. 1266 mm Breite auch als Doppelwaschtisch möglich.  
Bathroom furniture combinations available in widths 666, 966, 1066, 1266, 1366 and 1566 mm. Width 1266 mm, also available as double washbasin.  
Compositions de salle de bains disponibles en largeur de 666, 966, 1066, 1266, 1366 et 1566 mm. Largeur de 1266 mm également comme plan double vasque.  
Badkamermeubelcombinaties in 666, 966, 1066, 1266, 1366 en 1566 mm breed verkrijgbaar. 1266 mm breed ook als dubbele wastafel mogelijk.





**puris**  
4life









**puris**  
4life



# XPRESSION



Griffprofil alu / schwarz  
handle profile alu / black  
profil de poignée alu / noir  
griepprofil alu / zwart



„Ideal Standard CONNECT AIR“  
Keramik-Aufsatzwaschtisch, weiß  
ceramic top-mounted washbasin, white  
vasque à poser en céramique, blanc  
keramische opzetwastafel, wit



Mineralguss-Aufsatzwaschtisch, weiß\*  
cast mineral top-mounted washbasin, white\*  
vasque à poser en matériau de synthèse, blanc\*  
minerale opzetwastafel, wit\*

\*Waschtisch in verschiedenen Größen erhältlich.  
\*Washbasin is available in different sizes.  
\*La vasque à poser est livrable en dimensions différentes.  
\*Wastafel is verkrijgbaar in verschillende afmetingen.



## Qsolid®

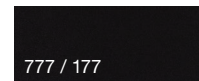

777 / 177  
Cosmos grey matt  
cosmos grey matt  
cosmos grey mat  
cosmos grey mat



891 / 191  
Quarzgrau matt  
quartz grey matt  
gris quartz mat  
kwartsgrijs mat

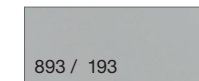

893 / 193  
Titangrau matt  
titanium grey matt  
titane gris mat  
titanium grijs mat

Frontdekore / Korpusdekore  
Front finishes / Carcass colours  
Façades / Corps de meuble  
Front kleuren / Corpus kleuren

° = Waschtischplattendekore  
° = washbasin top colours  
° = coloris plans de toilette pour  
vasque à poser  
° = wastafelplaat kleuren

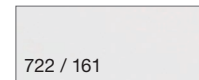

722 / 161  
Polarweiß hgl. / Weiß hgl.  
polarwhite hgl. / white hgl.  
blanc polaire haute brillance /  
blanc haute brillance  
hoogglans wit



670° / 170  
Halifax Eiche  
halifax oak  
chêne Halifax  
halifax eiken



785° / 185  
Eiche natur Nachbildung  
natural oak effect  
imitation chêne naturel  
eiken naturel folie

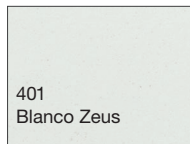

401  
Blanco Zeus

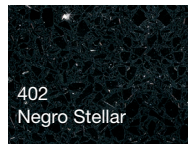

402  
Negro Stellar

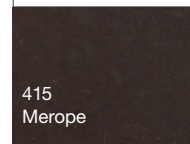

415  
Merope

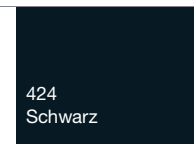

424  
Schwarz

Badmöbelkombinationen in 626, 926, 1226 und 1426 mm Breite erhältlich. 1426 mm Breite ausschließlich mit 2 Waschtischen möglich. Waschtischplatten in Frontdekor oder in „Qsolid“.  
Bathroom furniture combinations available in widths 626, 926, 1226 and 1426 mm. Width 1426 mm, only with 2 washbasins. Washbasin tops in front colour or in „Qsolid“.  
Compositions de salle de bains disponibles en largeur de 626, 926, 1266 et 1426 mm. Largeur de 1426 mm seulement avec 2 plans vasques. Plans de toilette pour vasques à poser sont disponible en couleur du façades ou en „Qsolid“.  
Badkamermeubelcombinaties in 626, 926, 1226 en 1426 mm breed verkrijgbaar. 1426 mm breed alleen met 2 wastafels. Wastafel platen in front kleuren en „Qsolid“.





**puris**  
4life





# 4LANDA

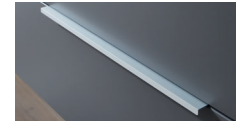

Griffleiste - chrom / alu matt / schwarz matt  
strip handle - chrome / alu matt / black matt  
profilé poignée - chrome / alu mat / noir mat  
greeplijst - chrom / alu mat / zwart mat

Griffprofil in Korpusdekor  
handle profile in Carcass colour  
profil de poignée en coloris de corps  
greepprofiel in corpus kleur



„Squared“ Keramik-Waschtisch, weiß  
“Squared” ceramic washbasin, white  
«Squared» plan vasque céramique, blanc  
“Squared” keramische wastafel, wit

„Till“ Keramik-Waschtisch, weiß  
“Till” ceramic washbasin, white  
«Till» plan vasque céramique, blanc  
“Till” keramische wastafel, wit

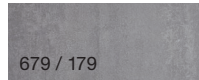

Betnoptik  
concrete effect  
aspect béton  
betnoptiek

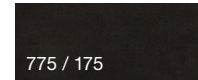

Stahl dunkel matt  
steel grey dark matt  
acier sombre mat  
staal donker mat



Cosmos grey matt  
cosmos grey matt  
cosmos grey mat  
cosmos grey mat

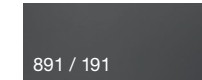

Quarzgrau matt  
quartz grey matt  
gris quartz mat  
kwartsgrijs mat

Frontdekore / Korpusdekore  
Front finishes / Carcass colours  
Façades / Corps de meuble  
Front kleuren / Corpus kleuren

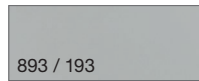

Titangrau matt  
titanium grey matt  
titane gris mat  
titanium grijs mat



Lack Weiß hgl.  
white lacquer hgl.  
laqué blanc haute brillance  
hoogglans lak wit

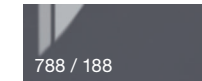

Lack Grau hgl.  
grey lacquer hgl.  
laqué gris haute brillance  
hoogglans lak grijs

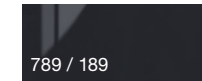

Lack Karbon hgl.  
carbon lacquer hgl.  
laqué carbone haute brillance  
hoogglans lak carbon

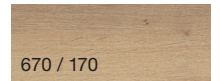

Halifax Eiche  
halifax oak  
chêne Halifax  
halifax eiken



Charleston Eiche  
charleston oak  
chêne Charleston  
charleston eiken



Eiche natur Nachbildung  
natural oak effect  
imitation chêne naturel  
eiken naturel folie



Eiche Trüffel  
truffle oak  
chêne truffier  
eiken truffel

Badmöbelkombinationen in 620, 810, 1020 und 1220 mm Breite erhältlich. 1020 mm Breite auch als Doppelwaschtisch möglich.  
„Squared“: 1220 mm Breite auch als Doppelwaschtisch möglich. „Till“: 1220 mm Breite ausschließlich als Doppelwaschtisch möglich.  
Bathroom furniture combinations available in widths 620, 810, 1020 and 1220 mm. Width 1020 mm also available as double washbasin.  
„Squared“: Width 1220 mm also available as double washbasin. „Till“: Width 1220 mm, only as double washbasin.  
Compositions de salle de bains disponibles en largeur de 620, 810, 1020 et 1220 mm. Largeur de 1020 mm également comme plan double vasque.  
„Squared“: Largeur de 1220 mm également comme plan double vasque. „Till“: Largeur de 1220 mm seulement comme plan double vasque.  
Badkamermeubelcombinaties in 620, 810, 1020 en 1220 mm breed verkrijgbaar. 1220 mm breed ook als dubbele wastafel mogelijk.  
„Squared“: 1220 mm breed ook als dubbele wastafel mogelijk. „Till“: 1220 mm breed alleen als dubbele wastafel mogelijk.





**puris**  
4life







Griffeleiste - chrom / alu matt / schwarz matt  
 strip handle - chrome / alu matt / black matt  
 profilé poignée - chrome / alu mat / noir mat  
 greeplijst - chroom / alu mat / zwart mat



„Squared“ Keramik-Aufsatzwaschtisch - Carbone matt / weiß  
 „Squared“ ceramic top-mounted washbasin - carbon matt / white  
 «Squared» vasque à poser en céramique - carbone mat / blanc  
 „Squared“ keramische opzetwastafel - carbon mat / wit

Mineralguss-Aufsatzwaschtisch, weiß  
 cast mineral top-mounted washbasin, white  
 vasque à poser en matériau de synthèse, blanc  
 minerale opzetwastafel, wit

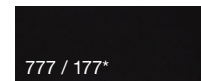

777 / 177\*  
 Cosmos grey matt  
 cosmos grey matt  
 cosmos grey mat  
 cosmos grey mat



891 / 191\*  
 Quarzgrau matt  
 quarz grey matt  
 gris quartz mat  
 kwartsgrijs mat

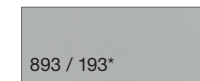

893 / 193\*  
 Titangrau matt  
 titanium grey matt  
 titane gris mat  
 titanium grijs mat

Frontdekore / Korpusdekore  
 Front finishes / Carcass colours  
 Façades / Corps de meuble  
 Front kleuren / Corpus kleuren

\* = Waschtischplattendekore / Abdeckplattendekore  
 \* = washbasin top colours / top cover colours  
 \* = coloris plan de toilette pour vasque à poser /  
 coloris de plateaux de recouvrement  
 \* = wastafelplaat kleuren / afdeklad kleuren

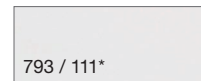

793 / 111\*  
 Edelweiß matt / Weiß matt  
 noble white matt / white matt  
 blanc pur mat / blanc mat  
 edelwit mat / wit mat

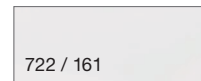

722 / 161  
 Polarweiß hgl. / Weiß hgl.  
 polarwhite hgl. / white hgl.  
 blanc polaire haute brillance /  
 blanc haute brillance  
 hoogglans wit



794 / 194\*  
 Eiche Sand  
 sand oak  
 chêne sable  
 zand eiken



174  
 Hunton Eiche  
 hunton oak  
 chêne Hunton  
 hunton eiken

Hunton Eiche (174) nur Waschtischplatten- und  
 Abdeckplattendekor.

Hunton oak (174) only washbasin plate and  
 top cover colour.

Chêne Hunton (174) seulement coloris plan de toilette pour  
 vasque à poser et coloris de plateaux de  
 recouvrement.

Hunton eiken (174) alleen wastafelplaat en  
 afdeklad kleur.

Badmöbelkombinationen von 606 bis 1546 mm Breite erhältlich. Alle Waschtische erhältlich in verschiedenen Größen.  
 Bathroom furniture combinations available in widths from 606 to 1546 mm. All Washbasins are available in different sizes.  
 Compositions de salle de bains disponibles en largeur de 606 à 1546 mm. Toutes les vasques sont livrables en dimensions différentes.  
 Backamermeubelcombinaties van 606 tot 1546 mm breed verkrijgbaar. Alle wastafels zijn verkrijgbaar in verschillende afmetingen.





**puris**  
4life



SLIM LINE







**puris**  
4life



# SLIM LINE



grifflos  
handleless  
sans poignée  
grieploos



Griffleiste - chrom / alu matt / schwarz matt  
strip handle - chrome / alu matt / black matt  
profilé poignée - chrome / alu mat / noir mat  
grieplijst - chroom / alu mat / zwart mat

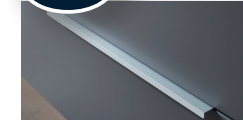

STONEPLUS® Waschtisch, weiß  
STONEPLUS® washbasin, white  
STONEPLUS® plan vasque, blanc  
STONEPLUS® wastafel, wit

## STONEPLUS®



690 / 187  
Lack Weiß hgl.  
white lacquer hgl.  
laqué blanc haute brillance  
hoogglans lak wit

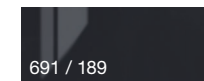

691 / 189  
Lack Karbon hgl.  
carbon lacquer hgl.  
laqué carbone haute brillance  
hoogglans lak carbon



694 / 194  
Eiche Sand  
sand oak  
chêne sable  
zand eiken

Frontdekore / Korpusdekore  
Front finishes / Carcass colours  
Façades / Corps de meuble  
Front kleuren / Corpus kleuren



692 / 180  
Charleston Eiche  
charleston oak  
chêne Charleston  
charleston eiken

Badmöbelkombinationen in 612, 912 und 1212 mm Breite erhältlich.  
Bathroom furniture combinations available in widths 612, 912 and 1212 mm.  
Compositions de salle de bains disponibles en largeur de 612, 912 et 1212 mm.  
Badkamermeubelcombinaties in 612, 912 en 1212 mm breed verkrijgbaar.





**puris**  
4life





Griffleiste alu matt  
strip handle alu matt  
profilé poignée alu mat  
greeplijst alu mat



Stangengriff chrom  
handle chrome  
poignée barre chrome  
stangengreep chrom

> Keramik-Waschtisch, weiß  
ceramic washbasin, white  
plan vasque céramique, blanc  
keramische wastafel, wit

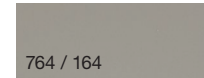

764 / 164  
Steingrau matt  
stonegrey matt  
gris pierre mat  
steengrijs mat

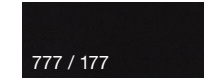

777 / 177  
Cosmos grey matt  
cosmos grey matt  
cosmos grey mat  
cosmos grey mat

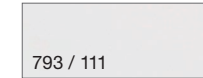

793 / 111  
Edelweiß matt / Weiß matt  
noble white matt / white matt  
blanc pur mat / blanc mat  
edelwit mat / wit mat

Frontdekore / Korpusdekore  
Front finishes / Carcass colours  
Façades / Corps de meuble  
Front kleuren / Corpus kleuren

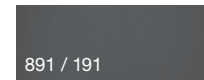

891 / 191  
Quarzgrau matt  
quartz grey matt  
gris quartz mat  
kwartsgrijs mat

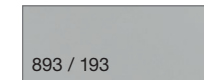

893 / 193  
Titangrau matt  
titanium grey matt  
titane gris mat  
titanium grijs mat



686 / 121  
Anthrazit hgl.  
anthracite hgl.  
anthracite haute brillance  
hoogglans antraciet

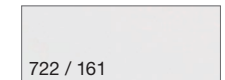

722 / 161  
Polarweiß hgl. / Weiß hgl.  
polarwhite hgl. / white hgl.  
blanc polaire haute brillance /  
blanc haute brillance  
hoogglans wit



680 / 180  
Charleston Eiche  
charleston oak  
chêne Charleston  
charleston eiken



784 / 184  
Eiche hell Nachbildung  
light oak effect  
imitation chêne clair  
licht eiken folie



785 / 185  
Eiche natur Nachbildung  
natural oak effect  
imitation chêne naturel  
eiken naturel folie



786 / 186  
Eiche Trüffel  
truffel oak  
chêne truffier  
eiken truffel



794 / 194  
Eiche Sand  
sand oak  
chêne sable  
zand eiken



792 / 192  
Ulme Nachbildung  
elm imitation  
imitation orme  
iepen hout folie

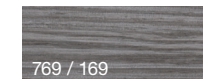

769 / 169  
Hacienda Grau  
hacienda grey  
gris exotique  
hacienda grijs



Badmöbelkombinationen in 660, 860, 960, 1060 und 1260 mm Breite erhältlich. 1260 mm Breite auch als Doppelwaschtisch möglich.  
Bathroom furniture combinations available in widths 660, 860, 960, 1060 and 1260 mm. Width 1260 mm also available as double washbasin.  
Compositions de salle de bains disponibles en largeur de 660, 860, 960, 1060 et 1260 mm. Largeur de 1260 mm également comme plan double vasque.  
Badkamermeubelcombinaties in 660, 860, 960, 1060 en 1260 mm breed verkrijgbaar. 1260 mm breed ook als dubbele wastafel mogelijk.





**puris**  
4life





Stangengriff chrom  
handle chrome  
poignée barre chrome  
stangengreep chrom



Keramik-Waschtisch, weiß  
ceramic washbasin, white  
plan vasque céramique, blanc  
keramische wastafel, wit



STONEPLUS® Waschtisch, weiß  
STONEPLUS® washbasin, white  
STONEPLUS® plan vasque, blanc  
STONEPLUS® wastafel, wit

## STONEPLUS®

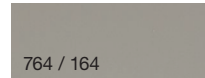

764 / 164  
Steingrau matt  
stonegrey matt  
gris pierre mat  
steengrijs mat

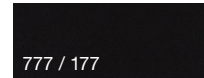

777 / 177  
Cosmos grey matt  
cosmos grey matt  
cosmos grey mat  
cosmos grey mat

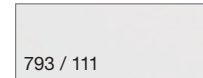

793 / 111  
Edelweiß matt / Weiß matt  
noble white matt / white matt  
blanc pur mat / blanc mat  
edelwit mat / wit mat

Frontdekore / Korpusdekore  
Front finishes / Carcass colours  
Façades / Corps de meuble  
Front kleuren / Corpus kleuren



891 / 191  
Quarzgrau matt  
quartz grey matt  
gris quartz mat  
kwartsgrijs mat

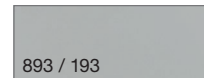

893 / 193  
Titangrau matt  
titanium grey matt  
titane gris mat  
titanium grijs mat

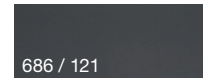

686 / 121  
Anthrazit hgl.  
anthracite hgl.  
anthracite haute brillance  
hoogglans antraciet

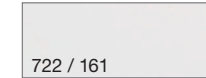

722 / 161  
Polarweiß hgl. / Weiß hgl.  
polarwhite hgl. / white hgl.  
blanc polaire haute brillance /  
blanc haute brillance  
hoogglans wit



680 / 180  
Charleston Eiche  
charleston oak  
chêne Charleston  
charleston eiken



784 / 184  
Eiche hell Nachbildung  
light oak effect  
imitation chêne clair  
licht eiken folie



785 / 185  
Eiche natur Nachbildung  
natural oak effect  
imitation chêne naturel  
eiken naturel folie



786 / 186  
Eiche Trüffel  
truffle oak  
chêne truffier  
eiken truffel



794 / 194  
Eiche Sand  
sand oak  
chêne sable  
zand eiken



792 / 192  
Ulme Nachbildung  
elm imitation  
imitation orme  
iepen hout folie



755 / 155  
Hacienda Schwarz  
hacienda black  
noir exotique  
hacienda zwart

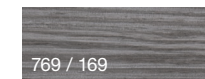

769 / 169  
Hacienda Grau  
hacienda grey  
gris exotique  
hacienda grijs

Badmöbelkombinationen in 620, 920 und 1220 mm Breite erhältlich. Keramik-Waschtisch: 650, 950 und 1250 mm Breite  
Bathroom furniture combinations available in widths 620, 920 and 1220 mm. Ceramic washbasin: width 650, 950 and 1250 mm  
Compositions de salle de bains disponibles en largeur de 620, 920 et 1220 mm. Plan vasque céramique: 650, 950 et 1250 mm largeur  
Badkamermeubelcombinaties in 620, 920 en 1220 mm breed verkrijgbaar. Keramische wastafel: 650, 950 en 1250 mm breed





**puris**  
4life



# ICE LINE



Push to open  
push to open  
push to open  
push to open

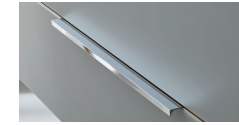

Griffleiste - chrom / alu matt / schwarz matt  
strip handle - chrome / alu matt / black matt  
profilé poignée - chrome / alu mat / noir mat  
grieplijst - chroom / alu mat / zwart mat



heizbar  
heated  
miroir chauffant  
spiegelverwarming



Glas-Waschtisch - optiwhite / optiwhite matt  
glass washbasin - optiwhite / optiwhite matt  
plan vasque en verre - optiwhite / optiwhite mat  
glazen wastafel - optiwhite / optiwhite mat



## STONEPLUS®



STONEPLUS® Waschtisch, weiß  
STONEPLUS® washbasin, white  
STONEPLUS® plan vasque, blanc  
STONEPLUS® wastafel, wit



heizbar  
heated  
miroir chauffant  
spiegelverwarming



894 / 194 -307-  
Glas Optiwhite matt  
glass optiwhite matt  
verre optiwhite mat  
glas optiwhite mat

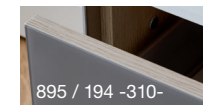

895 / 194 -310-  
Glas Grau matt  
glass grey matt  
verre gris mat  
glas grijs mat



794\*  
Eiche Sand  
sand oak  
chêne sable  
zand eiken

Frontdekore / Korpusdekore  
Front finishes / Carcass colours  
Façades / Corps de meuble  
Front kleuren / Corpus kleuren

\*nur Frontdekor  
\*only front finish  
\*seulement façade  
\*alleen front kleur

Badmöbelkombinationen in 620, 920 und 1220 mm Breite erhältlich. 1220 mm Breite auch als Doppelwaschtisch möglich. Alle Korpusdekore bestehend aus Korpusdekor Eiche Sand (194) mit Sichtseitendekor Glas (-307- oder -310-).  
Bathroom furniture combinations available in widths 620, 920 and 1220 mm. Width 1220 mm also available as double washbasin. All Carcass finishes consist of the Carcass finish sand oak (194) with visible side finish in glass (-307- or -310-).  
Compositions de salle de bains disponibles en largeur de 620, 920 et 1220 mm. Largeur de 1220 mm également comme plan double vasque. Tous les décors corps avec décor côtés chêne sable (194) avec décor côtés visibles verre (-307- ou -310-).  
Badkamermeubelcombinaties in 620, 920 en 1220 mm breed verkrijgbaar. 1220 mm breed ook als dubbele wastafel mogelijk. De glazen corpus (-307- en -310-) hebben een zand eiken (194) binnen en rand afwerking.





**puris**  
4life



# BRILLANT

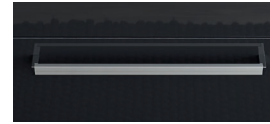

Stangengriff chrom + chrom matt  
handle chrome + chrome matt  
poignée barre chrome + chrome mat  
stangengreep chrom + chrom mat



**evermite®**



Glas-Waschtisch - optiwhite / quarzitgrau  
glass washbasin - optiwhite / quartzite grey  
plan vasque en verre - optiwhite / gris quartzite  
glazen wastafel - optiwhite / kwartsiet grijs

evermite® Waschtisch, weiß  
evermite® washbasin, white  
evermite® plan vasque, blanc  
evermite® wastafel, wit



Lack Weiß hgl.  
white lacquer hgl.  
laqué blanc haute brillance  
hoogglans lak wit

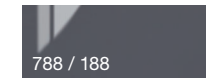

Lack Grau hgl.  
grey lacquer hgl.  
laqué gris haute brillance  
hoogglans lak grijs

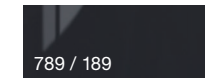

Lack Karbon hgl.  
carbon lacquer hgl.  
laqué carbone haute brillance  
hoogglans lak carbon

Frontdekore / Korpusdekore  
Front finishes / Carcass colours  
Façades / Corps de meuble  
Front kleuren / Corpus kleuren

Badmöbelkombinationen in 606, 906 und 1206 mm Breite erhältlich. 1206 mm Breite auch als Doppelwaschtisch möglich.  
Bathroom furniture combinations available in widths 606, 906 and 1206 mm. Width 1206 mm also available as double washbasin.  
Compositions de salle de bains disponibles en largeur de 606, 906 et 1206 mm. Largeur de 1206 mm également comme plan double vasque.  
Badkamermeubelcombinaties in 606, 906 en 1206 mm breed verkrijgbaar. 1206 mm breed ook als dubbele wastafel mogelijk.





**puris**  
4life



# COOL LINE







129  
Chrom  
chrome  
chromé  
chromium

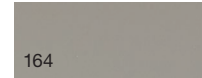

164  
Steingrau matt  
stonegrey matt  
gris pierre mat  
steengrijs mat



177  
Cosmos grey matt  
cosmos grey matt  
cosmos grey mat  
cosmos grey mat

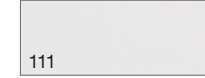

111  
Weiß matt  
white matt  
blanc mat  
wit mat

Dekorline Zwischenplatte  
Dekorline board  
Liseré décoratif  
Decor blad



193  
Titangrau matt  
titanium grey matt  
titane gris mat  
titanium grijs mat



191  
Quarzgrau matt  
quartz grey matt  
gris quartz mat  
kwartsgrijs mat

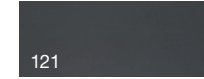

121  
Anthrazit hgl.  
anthracite hgl.  
anthracite haute brillance  
hoogglans antraciet



161  
Weiß hgl.  
white hgl.  
blanc haute brillance  
hoogglans wit



180  
Charleston Eiche  
charleston oak  
chêne Charleston  
charleston eiken



184  
Eiche hell Nachbildung  
light oak effect  
imitation chêne clair  
licht eiken folie



185  
Eiche natur Nachbildung  
natural oak effect  
imitation chêne naturel  
eiken naturel folie



186  
Eiche Trüffel  
truffle oak  
chêne truffier  
eiken truffel



194  
Eiche Sand  
sand oak  
chêne sable  
zand eiken



192  
Ulme Nachbildung  
elm imitation  
imitation orme  
iepen hout folie



155  
Hacienda Schwarz  
hacienda black  
noir exotique  
hacienda zwart



169  
Hacienda Grau  
hacienda grey  
gris exotique  
hacienda grijs



**puris**  
4life



# COOL LINE



**STONEPLUS®**

STONEPLUS® Waschtisch, weiß  
 STONEPLUS® washbasin, white  
 STONEPLUS® plan vasque, blanc  
 STONEPLUS® wastafel, wit

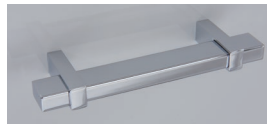

Stangengriff chrom  
 handle chrome  
 poignée barre chrome  
 stangengreep chrom



Stangengriff chrom  
 handle chrome  
 poignée barre chrome  
 stangengreep chrom



Stangengriff chrom + chrom matt  
 handle chrome + chrome matt  
 poignée barre chrome + chrome mat  
 stangengreep chrom + chrom mat



Keramik-Waschtisch, weiß  
 ceramic washbasin, white  
 plan vasque en céramique, blanc  
 keramische wastafel, wit



Glas-Waschtisch - optiwhite / quarzitgrau / optiwhite matt  
 glass washbasin - optiwhite / quartzite grey / optiwhite matt  
 plan vasque en verre - optiwhite / gris quartzite / optiwhite mat  
 glazen wastafel - optiwhite / kwartsiet grijs / optiwhite mat

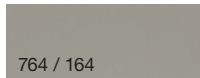

764 / 164  
 Steingrau matt  
 stonegrey matt  
 gris pierre mat  
 steengrijs mat

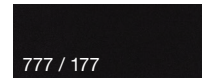

777 / 177  
 Cosmos grey matt  
 cosmos grey matt  
 cosmos grey mat  
 cosmos grey mat

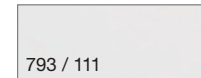

793 / 111  
 Edelweiß matt / Weiß matt  
 noble white matt / white matt  
 blanc pur mat / blanc mat  
 edelwit mat / wit mat

Frontdekore / Korpusdekore  
 Front finishes / Carcass colours  
 Façades / Corps de meuble  
 Front kleuren / Corpus kleuren



891 / 191  
 Quarzgrau matt  
 quartz grey matt  
 gris quartz mat  
 kwartsgrijs mat

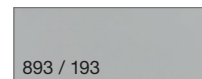

893 / 193  
 Titangrau matt  
 titanium grey matt  
 titane gris mat  
 titanium grijs mat



686 / 121  
 Anthrazit hgl.  
 anthracite hgl.  
 anthracite haute brillance  
 hoogglans antraciet

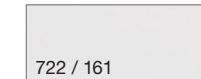

722 / 161  
 Polarweiß hgl. / Weiß hgl.  
 polarwhite hgl. / white hgl.  
 blanc polaire haute brillance /  
 blanc haute brillance  
 hoogglans wit



680 / 180  
 Charleston Eiche  
 charleston oak  
 chêne Charleston  
 charleston eiken



784 / 184  
 Eiche hell Nachbildung  
 light oak effect  
 imitation chêne clair  
 licht eiken folie



785 / 185  
 Eiche natur Nachbildung  
 natural oak effect  
 imitation chêne naturel  
 eiken naturel folie



786 / 186  
 Eiche Trüffel  
 truffle oak  
 chêne truffler  
 eiken truffel



794 / 194  
 Eiche Sand  
 sand oak  
 chêne sable  
 zand eiken



792 / 192  
 Ulme Nachbildung  
 elm imitation  
 imitation orme  
 iepen hout folie



755 / 155  
 Hacienda Schwarz  
 hacienda black  
 noir exotique  
 hacienda zwart

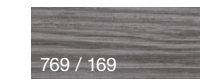

769 / 169  
 Hacienda Grau  
 hacienda grey  
 gris exotique  
 hacienda grijs



Badmöbelkombinationen in 620, 920 und 1220 mm Breite erhältlich. 1220 mm Breite auch als Doppelwaschtisch möglich.  
 Bathroom furniture combinations available in widths 620, 920 and 1220 mm. Width 1220 mm also available as double washbasin.  
 Compositions de salle de bains disponibles en largeur de 620, 920 et 1220 mm. Largeur de 1220 mm également comme plan double vasque.  
 Badkamermeubelcombinaties in 620, 920 en 1220 mm breed verkrijgbaar. 1220 mm breed ook als dubbele wastafel mogelijk.





**puris**  
4life





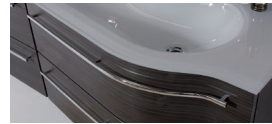

Stangengriff chrom  
handle chrome  
poignée barre chrome  
stangengreep chrom



Glas-Waschtisch - optiwhite / quarzitgrau  
glass washbasin - optiwhite / quartzite grey  
plan vasque en verre - optiwhite / gris quartzite  
glazen wastafel - optiwhite / kwartsiet grijs



**evermite®**



evermite® Waschtisch, weiß  
evermite® washbasin, white  
evermite® plan vasque, blanc  
evermite® wastafel, wit

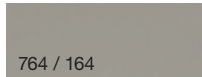

764 / 164  
Steingrau matt  
stonegrey matt  
gris pierre mat  
steengrijs mat

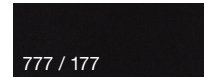

777 / 177  
Cosmos grey matt  
cosmos grey matt  
cosmos grey mat  
cosmos grey mat

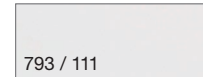

793 / 111  
Edelweiß matt / Weiß matt  
noble white matt / white matt  
blanc pur mat / blanc mat  
edelwit mat / wit mat

Frontdekore / Korpusdekore  
Front finishes / Carcass colours  
Façades / Corps de meuble  
Front kleuren / Corpus kleuren



891 / 191  
Quarzgrau matt  
quartz grey matt  
gris quartz mat  
kwartsgrijs mat

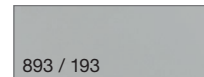

893 / 193  
Titangrau matt  
titanium grey matt  
titane gris mat  
titanium grijs mat

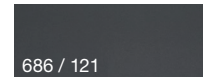

686 / 121  
Anthrazit hgl.  
anthracite hgl.  
anthracite haute brillance  
hoogglaans antraciet

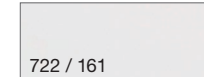

722 / 161  
Polarweiß hgl. / Weiß hgl.  
polarwhite hgl. / white hgl.  
blanc polaire haute brillance /  
blanc haute brillance  
hoogglaans wit



680 / 180  
Charleston Eiche  
charleston oak  
chêne Charleston  
charleston eiken



784 / 184  
Eiche hell Nachbildung  
light oak effect  
imitation chêne clair  
licht eiken folie



785 / 185  
Eiche natur Nachbildung  
natural oak effect  
imitation chêne naturel  
eiken naturel folie



786 / 186  
Eiche Trüffel  
truffle oak  
chêne truffier  
eiken truffel



794 / 194  
Eiche Sand  
sand oak  
chêne sable  
zand eiken



792 / 192  
Ulme Nachbildung  
elm imitation  
imitation orme  
iepen hout folie



755 / 155  
Hacienda Schwarz  
hacienda black  
noir exotique  
hacienda zwart



769 / 169  
Hacienda Grau  
hacienda grey  
gris exotique  
hacienda grijs



Badmöbelkombinationen in 906, 1206, 1406 und 1806 mm Breite erhältlich. 1806 (1812) mm Breite ausschließlich als Doppelwaschtisch möglich. Glas-Waschtisch: 912, 1212, 1412 und 1812 mm Breite  
Bathroom furniture combinations available in widths 906, 1206, 1406 and 1806 mm. Width 1806 (1812) mm, only as double washbasin. Glass washbasin: width 912, 1212, 1412 and 1812 mm  
Compositions de salle de bains disponibles en largeur de 906, 1206, 1406 et 1806 mm. Largeur de 1806 (1812) mm seulement comme plan double vasque. Plan vasque en verre: 912, 1212, 1412 et 1812 mm largeur  
Badkamermeubelcombinaties in 906, 1206, 1406 en 1806 mm breed verkrijgbaar. 1806 (1812) mm breed alleen als dubbele wastafel mogelijk. Glazen wastafel: 912, 1212, 1412 en 1812 mm breed





**puris**  
4life



# STAR LINE

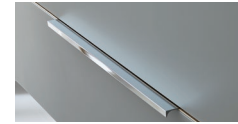
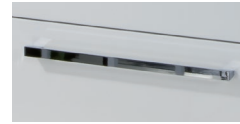

Stangengriff - chrom (schmal) / chrom (dick)  
handle - chrome (narrow) / chrome (expanded)  
poignée barre - chrome (étroite) / chrome (large)  
stangengreep - chroom (smal) / chroom (breed)

Griffleiste - chrom / alu matt / schwarz matt  
strip handle - chrome / alu matt / black matt  
profilé poignée - chrome / alu mat / noir mat  
greeplijst - chroom / alu mat / zwart mat



Glas-Waschtisch - optiwhite / quartzitgrau  
glass washbasin - optiwhite / quartzite grey  
plan vasque en verre - optiwhite / gris quartzite  
glazen wastafel - optiwhite / kwartsiet grijs

## STONEPLUS®

## evermite®



STONEPLUS® Waschtisch, weiß  
STONEPLUS® washbasin, white  
STONEPLUS® plan vasque, blanc  
STONEPLUS® wastafel, wit

evermite® Waschtisch, weiß  
evermite® washbasin, white  
evermite® plan vasque, blanc  
evermite® wastafel, wit



764 / 164

Steingrau matt  
stonegrey matt  
gris pierre mat  
steengrijs mat

777 / 177

Cosmos grey matt  
cosmos grey matt  
cosmos grey mat  
cosmos grey mat

793 / 111

Edelweiß matt / Weiß matt  
noble white matt / white matt  
blanc pur mat / blanc mat  
edelwit mat / wit mat

Frontdekore / Korpusdekore  
Front finishes / Carcass colours  
Façades / Corps de meuble  
Front kleuren / Corpus kleuren

891 / 191

Quarzgrau matt  
quartz grey matt  
gris quartz mat  
kwartsgrijs mat

893 / 193

Titangrau matt  
titanium grey matt  
titane gris mat  
titanium grijs mat

686 / 121

Anthrazit hgl.  
anthracite hgl.  
anthracite haute brillance  
hoogglans antraciet

722 / 161

Polarweiß hgl. / Weiß hgl.  
polarwhite hgl. / white hgl.  
blanc polaire haute brillance /  
blanc haute brillance  
hoogglans wit

680 / 180

Charleston Eiche  
charleston oak  
chêne Charleston  
charleston eiken

784 / 184

Eiche hell Nachbildung  
light oak effect  
imitation chêne clair  
licht eiken folie

785 / 185

Eiche natur Nachbildung  
natural oak effect  
imitation chêne naturel  
eiken naturel folie

786 / 186

Eiche Trüffel  
truffle oak  
chêne truffier  
eiken truffel

794 / 194

Eiche Sand  
sand oak  
chêne sable  
zand eiken

792 / 192

Ulme Nachbildung  
elm imitation  
imitation orme  
iepen hout folie

755 / 155

Hacienda Schwarz  
hacienda black  
noir exotique  
hacienda zwart

769 / 169

Hacienda Grau  
hacienda grey  
gris exotique  
hacienda grijs



Badmöbelkombinationen in 906, 1206, 1406 und 1606 mm Breite erhältlich. 1206 und 1406 mm Breite auch als Doppelwaschtisch möglich. 1606 mm Breite ausschließlich als Doppelwaschtisch möglich.  
Bathroom furniture combinations available in widths 906, 1206, 1406 and 1606 mm. Width 1206 and 1406 mm also available as double washbasin. Width 1606 mm only as double washbasin.

Compositions de salle de bains disponibles en largeur de 906, 1206, 1406 et 1606 mm. Largeur de 1206 et 1406 mm également comme plan double vasque. Largeur de 1606 mm seulement comme plan double vasque.

Badkamermeubelcombinaties in 906, 1206, 1406 en 1606 mm breed verkrijgbaar. 1206 en 1406 mm breed ook leverbaar met 2 kraangaten of als dubbele wastafel. 1606 mm breed alleen leverbaar met 2 kraangaten of als dubbele wastafel.





**puris**  
4life



# CRESCENDO



Stangengriff chrom  
handle chrome  
poignée barre chrome  
stangengreep chrom



Glas-Waschtisch - optiwhite / quarzitgrau  
glass washbasin - optiwhite / quartzite grey  
plan vasque en verre - optiwhite / gris quartzite  
glazen wastafel - optiwhite / kwartsiet grijs



Mineralguss-Waschtisch, weiß  
cast mineral washbasin, white  
plan vasque en matériau de synthèse, blanc  
minerale wastafel, wit

**evermite®**



evermite® Waschtisch, weiß  
evermite® washbasin, white  
evermite® plan vasque, blanc  
evermite® wastafel, wit

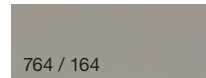

Steingrau matt  
stonegrey matt  
gris pierre mat  
steengrijs mat

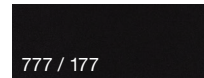

Cosmos grey matt  
cosmos grey matt  
cosmos grey mat  
cosmos grey mat

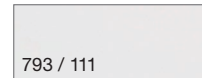

Edelweiß matt / Weiß matt  
noble white matt / white matt  
blanc pur mat / blanc mat  
edelwit mat / wit mat

Frontdekore / Korpusdekore  
Front finishes / Carcass colours  
Façades / Corps de meuble  
Front kleuren / Corpus kleuren



Quarzgrau matt  
quarz grey matt  
gris quartz mat  
kwartsgrijs mat

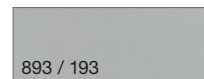

Titangrau matt  
titanium grey matt  
titane gris mat  
titanium grijs mat

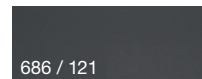

Anthrazit hgl.  
anthracite hgl.  
anthracite haute brillance  
hoogglans antraciet

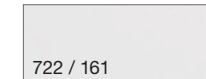

Polarweiß hgl. / Weiß hgl.  
polarwhite hgl. / white hgl.  
blanc polaire haute brillance /  
blanc haute brillance  
hoogglans wit



Charleston Eiche  
charleston oak  
chêne Charleston  
charleston eiken

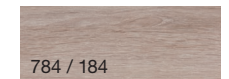

Eiche hell Nachbildung  
light oak effect  
imitation chêne clair  
licht eiken folie



Eiche natur Nachbildung  
natural oak effect  
imitation chêne naturel  
eiken naturel folie



Eiche Trüffel  
truffle oak  
chêne truffier  
eiken truffel



Eiche Sand  
sand oak  
chêne sable  
zand eiken



Ulme Nachbildung  
elm imitation  
imitation orme  
iepen hout folie



Hacienda Schwarz  
hacienda black  
noir exotique  
hacienda zwart

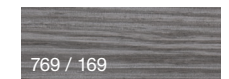

Hacienda Grau  
hacienda grey  
gris exotique  
hacienda grijs

Badmöbelkombinationen in 906, 1206 und 1406 mm Breite erhältlich.  
Bathroom furniture combinations available in widths 906, 1206 and 1406 mm.  
Compositions de salle de bains disponibles en largeur de 906, 1206 et 1406 mm.  
Badkamermeubelcombinaties in 906, 1206 en 1406 mm breed verkrijgbaar.





**puris**  
4life



# CLASSIC LINE

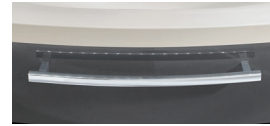

Stangengriff chrom  
handle chrome  
poignée barre chrome  
stangengreep chrom



Glas-Waschtisch - optiwhite / quartzitgrau  
glass washbasin - optiwhite / quartzite grey  
plan vasque en verre - optiwhite / gris quartzite  
glazen wastafel - optiwhite / kwartsiet grijs

**evermite®**



evermite® Waschtisch, weiß  
evermite® washbasin, white  
evermite® plan vasque, blanc  
evermite® wastafel, wit

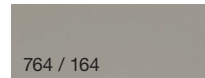

764 / 164  
Steingrau matt  
stonegrey matt  
gris pierre mat  
steengrijs mat

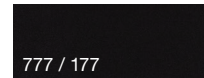

777 / 177  
Cosmos grey matt  
cosmos grey matt  
cosmos grey mat  
cosmos grey mat

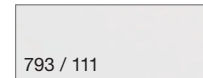

793 / 111  
Edelweiß matt / Weiß matt  
noble white matt / white matt  
blanc pur mat / blanc mat  
edelwit mat / wit mat

Frontdekore / Korpusdekore  
Front finishes / Carcass colours  
Façades / Corps de meuble  
Front kleuren / Corpus kleuren



891 / 191  
Quarzgrau matt  
quartz grey matt  
gris quartz mat  
kwartsgrijs mat

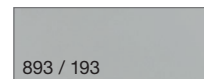

893 / 193  
Titangrau matt  
titanium grey matt  
titane gris mat  
titanium grijs mat

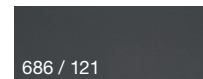

686 / 121  
Anthrazit hgl.  
anthracite hgl.  
anthracite haute brillance  
hoogglans antraciet

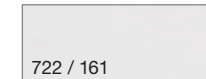

722 / 161  
Polarweiß hgl. / Weiß hgl.  
polarwhite hgl. / white hgl.  
blanc polaire haute brillance /  
blanc haute brillance  
hoogglans wit



680 / 180  
Charleston Eiche  
charleston oak  
chêne Charleston  
charleston eiken



784 / 184  
Eiche hell Nachbildung  
light oak effect  
imitation chêne clair  
licht eiken folie

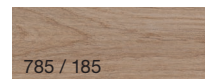

785 / 185  
Eiche natur Nachbildung  
natural oak effect  
imitation chêne naturel  
eiken naturel folie



786 / 186  
Eiche Trüffel  
truffle oak  
chêne truffier  
eiken truffel



794 / 194  
Eiche Sand  
sand oak  
chêne sable  
zand eiken



792 / 192  
Ulme Nachbildung  
elm imitation  
imitation orme  
iepen hout folie



755 / 155  
Hacienda Schwarz  
hacienda black  
noir exotique  
hacienda zwart

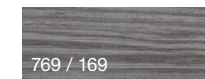

769 / 169  
Hacienda Grau  
hacienda grey  
gris exotique  
hacienda grijs

Badmöbelkombinationen in 712, 912, 1212 und 1412 mm Breite erhältlich. 1412 mm Breite auch als Doppelwaschtisch möglich (ausgenommen Glas).  
Bathroom furniture combinations available in widths 712, 912, 1212 and 1412 mm. Width 1412 mm also available as double washbasin (except glass).  
Compositions de salle de bains disponibles en largeur de 712, 912, 1212 et 1412 mm. Largeur de 1412 mm également comme plan double vasque (sauf verre).  
Badkamermeebelcombinaties in 712, 912, 1212 en 1412 mm breed verkrijgbaar. 1412 mm breed ook als dubbele wastafel mogelijk (behalve glas).





**puris**  
4life





# VARIADO 2.0



Ideal Standard CONNECT AIR



Ideal Standard CUBE



grifflos mit Griffmulde  
handless with recessed grip  
sans poignée avec prise de main  
en creux  
grieploos met grieplijstfresing in  
het front

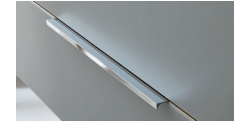

Griffleiste - chrom / alu matt / schwarz matt  
strip handle - chrome / alu matt / black matt  
profilé poignée - chrome / alu mat / noir mat  
grieplijst - chroom / alu mat / zwart mat



„Málaga“



Villeroy&Boch LOOP



Villeroy&Boch LOOP



Villeroy&Boch MEMENTO  
CeramicPlus



Keramik-Aufsatzwaschtische, weiß  
ceramic top-mounted washbasins, white  
vasques à poser céramique, blanc  
keramische opzetwastafels, wit

\*Waschtisch ist erhältlich in verschiedenen Größen.  
\*Washbasin is available in different sizes.  
\*La vasque à poser est livrable en dimensions différentes.  
\*Wastafel is verkrijgbaar in verschillende afmetingen.



„Melbourne\*\*“



„Squared“

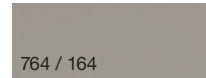

764 / 164

Steingrau matt  
stonegrey matt  
gris pierre mat  
steengrijs mat

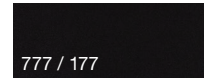

777 / 177

Cosmos grey matt  
cosmos grey matt  
cosmos grey mat  
cosmos grey mat

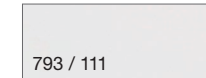

793 / 111

Edelweiß matt / Weiß matt  
noble white matt / white matt  
blanc pur mat / blanc mat  
edelwit mat / wit mat

Frontdekore / Korpusdekore  
Front finishes / Carcass colours  
Façades / Corps de meuble  
Front kleuren / Corpus kleuren

° Frontdekore nur grifflos  
° Front finishes available only handless  
° Façades disponible sans poignée  
° Front kleuren alleen grieploos



„Kingston“



„Perth“

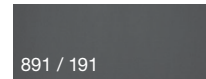

891 / 191

Quarzgrau matt  
quartz grey matt  
gris quartz mat  
kwartsgrijs mat

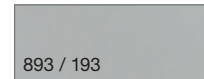

893 / 193

Titangrau matt  
titanium grey matt  
titane gris mat  
titanium grijs mat

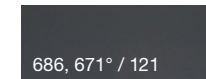

686, 671° / 121

Anthrazit hgl.  
anthracite hgl.  
anthracite haute brillance  
hoogglans antraciet

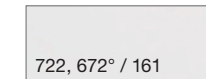

722, 672° / 161

Polarweiß hgl. / Weiß hgl.  
polarwhite hgl. / white hgl.  
blanc polaire haute brillance /  
blanc haute brillance  
hoogglans wit

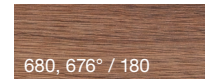

680, 676° / 180

Charleston Eiche  
charleston oak  
chêne Charleston  
charleston eiken

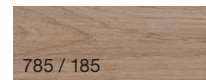

785 / 185

Eiche natur Nachbildung  
natural oak effect  
imitation chêne naturel  
eiken naturel folie



786, 673° / 186

Eiche Trüffel  
truffle oak  
chêne truffier  
eiken truffel



794, 675° / 194

Eiche Sand  
sand oak  
chêne sable  
zand eiken



792 / 192

Ulme Nachbildung  
elm imitation  
imitation orme  
iepen hout folie

Badmöbelkombinationen in 706, 1006, 1206, 1406 und 1706 mm Breite erhältlich. 1406 und 1706 mm Breite auch als Doppelwaschtisch möglich. Waschtischplatten in Korpusdekore maßflexibel bis 2600 mm.  
Bathroom furniture combinations available in widths 706, 1006, 1206, 1406 and 1706 mm. Width 1406 and 1706 mm also available as double washbasin. Washbasin tops in Carcass colour are available in variable dimensions up to 2600 mm.  
Compositions de salle de bains disponibles en largeur de 706, 1006, 1206, 1406 et 1706 mm. Largeur de 1406 et 1706 mm également comme plan double vasque. Plan de toilette pour vasque à poser, en couleur corps, possible jusqu'à 2600 mm.  
Badkamermeubelcombinaties in 706, 1006, 1206, 1406 en 1706 mm breed verkrijgbaar. 1406 en 1706 mm breed ook leverbaar met 2 kraangaten of als dubbele wastafel. Houten wastafelplaten zijn verkrijgbaar in variabele lengte tot max. 2600 mm.



EXKLUSIV für Sie

EXCLUSIVELY for you

EXCLUSIF pour vous

EXKLUSIEF voor u

LED-Emotionbeleuchtung (Farbwechselsteuerung)\*  
LED-emotion colour change system\*  
Éclairage des émotions LED (capteur pour changement de couleur)\*  
LED-emotieverlichting (kleurverwisselbaar)\*

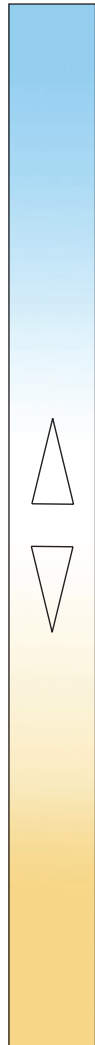

kaltweiß  
cool white  
blanc froid  
koudwit

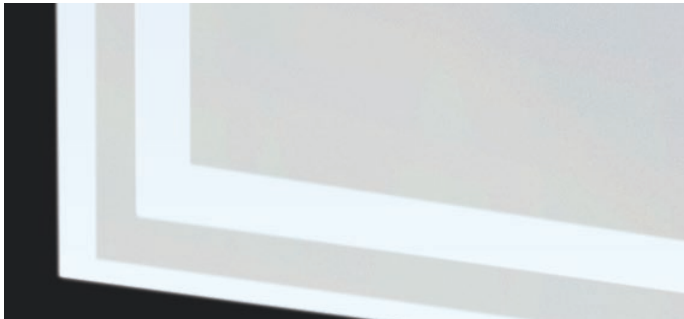

# LED

3 Helligkeitsstufen mit stufenlosem Farbwechsel  
3 brightness levels with continuous colour change  
3 niveaux de luminosité avec variation de couleur infiniment variable  
kleurverandering van 3 kleuren led die naadloos in elkaar overgaan



warmweiß  
warm white  
blanc chaud  
warmwit

\*Gilt nur für bestimmte Artikel (siehe Typenliste).

\*Valid only for some articles (see type list).

\*Ne concerne que certains articles (voir liste des références).

\*Geldt alleen voor bepaalde artikelen(zie de losse kasten).

Heizung für Spiegelflächen\*  
Heating for mirror surface\*  
Chauffage pour surfaces miroir\*  
Spiegelverwarming\*



- nie wieder beschlagene Spiegel im Bad
- geringer Stromverbrauch
- automatische Abschaltung

- never again fogged up mirrors
- low power consumption
- automatic switching off

- plus jamais de buée sur le miroir de votre salle de bain
- faible consommation d'énergie
- connexion automatique

- nooit meer een beslagen spiegel in uw badkamer
- gering stroomverbruik
- automatische uitschakeling



\*Gilt nur für bestimmte Artikel (siehe Typenliste).

\*Valid only for some articles (see type list).

\*Ne concerne que certains articles (voir liste des références).

\*Geldt alleen voor bepaalde artikelen(zie de losse kasten).



EXKLUSIV *für Sie*

EXCLUSIVELY *for you*

EXCLUSIF *pour vous*

EXKLUSIEF *voor u*

# STONEPLUS® evermite®

Der besondere Schutz für Ihren Waschtisch. Mineralguss neu erleben.  
Dank der einzigartigen Oberfläche.  
The special protection for your washbasin.  
Experience mineral cast in a new way, thanks to the unique surface.  
La protection spéciale pour votre plan de toilette. Expérimenter un nouveau matériau de synthèse. Grâce à sa surface unique.  
De bijzondere bescherming voor uw wastafel. Een minerale wastafel nieuw beleven.  
Dankzij het unieke oppervlak.



fleckenbeständig  
stain resistant  
résistant aux taches  
vlekbestendig



ultrahygienisch  
ultra-hygienic  
ultra hygiénique  
hygiënischer



UV-beständig  
UV-resistant  
résistant aux UV  
UV bestendig



reparierbar  
repairable  
réparable  
repareerbaar



widerstandsfähig  
resistance  
résistant  
krasvaster



pflegeleicht  
easy-care  
facile à nettoyer  
makkelijker te onderhouden



ideale Glätte  
ideal smoothing  
idéalement lisse  
gladder oppervlak

Bitte beachten Sie die Pflege- und Gebrauchshinweise.  
Please follow the care and use instructions.  
Veuillez à respecter les conseils d'entretien et de nettoyage.  
Let u aub op de montage en gebruiksaanwijzingen.



Dieses Waschtischplattenmaterial hat einen Quarzanteil von mehr als 90%, was dem Material eine außergewöhnliche Härte und Widerstandskraft verleiht. Die Quarzartikel werden in verschiedenen Körnungsgößen geschichtet, verpresst und unter Wärmeinsatz verdichtet. So entsteht eine Arbeitsplatte aus Quarz mit bakteriostatischem Hygieneschutz.

This washbasin top material has a quartz content of more than 90%, which gives the material exceptional hardness and resistance. The quartz articles are layered in various grain sizes, pressed and compacted using heat. The result is a quartz worktop with bacteriostatic hygiene protection.

Le matériau du dessus de plans de toilette a une teneur en quartz de plus de 90%, ce qui lui confère une dureté et une résistance exceptionnelles. Les articles en quartz sont stratifiés en différentes granulométries, pressés et compactés à chaud. Le résultat est un plan de travail en quartz avec protection hygiénique bactériostatique.

Dit wastafelplaten materiaal heeft een kwartsgehalte van meer dan 90%, wat het materiaal een uitzonderlijke hardheid en weerstand geeft. De kwartsartikelen zijn gelaagd in verschillende korrelgroottes, geperst en verdicht met behulp van warmte. Het resultaat is een werkblad van kwarts met bacteriostatische hygiënische bescherming.





Optionales Zubehör + optionale Ergänzungsschränke  
 optional accessories + optional additional cabinets  
 accessoires en option + meubles complémentaires  
 optionele accessoires + losse kasten





# ROUNDS

Planungsbeispiele  
 Planning examples  
 Exemples de composition  
 Sets

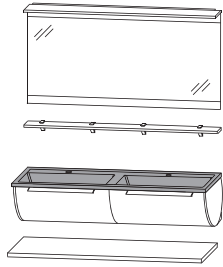

ROK-9814-1D  
 1432

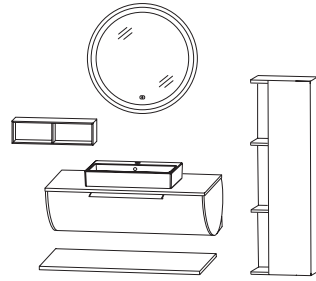

ROK-0190-1  
 926 + 400

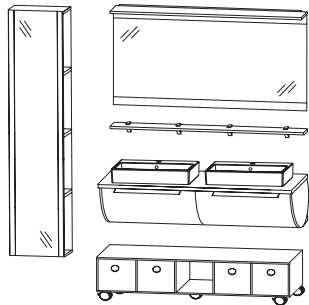

ROK-0114-1D  
 400 + 1426

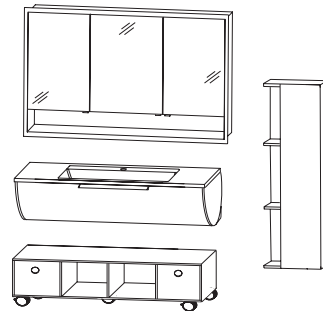

ROS-6112-1  
 1232 + 400

Türen / Auszüge / Schubkästen mit Dämpfung  
 Doors / pull out units / drawers with buffered closing  
 Portes / tiroirs / coulissants avec amortisseur  
 Deuren en lades met softclose

Breite in mm  
 Width in mm  
 Largeur en mm  
 Breedte in mm

# MODERN LIFE

Planungsbeispiele  
 Planning examples  
 Exemples de composition  
 Sets

Türen / Auszüge / Schubkästen mit Dämpfung  
 Doors / pull out units / drawers with buffered closing  
 Portes / tiroirs / coulissants avec amortisseur  
 Deuren en lades met softclose

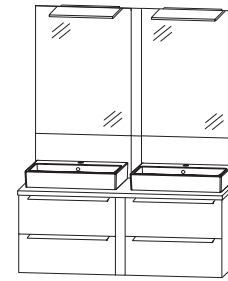

MLK-0112-1D  
 1266

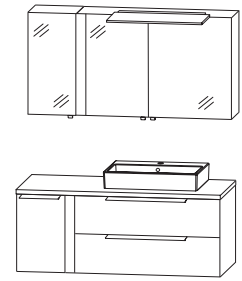

MLK-0112-2  
 1266

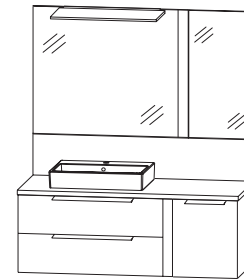

MLK-0113-1  
 1366

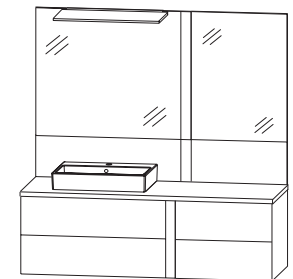

MLK-0115-1  
 1566

Abbildungen mit Griffleiste, auch in grifflos (push-to-open) möglich.  
 Technical drawings with handle bar, also available handleless (push-to-open).  
 Les exemples de composition avec profilé poignée également possible sans poignées (push-to-open).  
 Afbeeldingen zijn met greeplijst, greeploos (push-to-open) zijn ook mogelijk.

Breite in mm  
 Width in mm  
 Largeur en mm  
 Breedte in mm

Ergänzungsschränke - Auszug aus dem Typenplan  
 Additional cabinets - part of the type list  
 Meubles complémentaires - extrait du plan type  
 Losse kasten - getoonde kasten zijn een selectie uit de kast mogelijkheden



UNA-3230 L (R)  
 OMA-2160-K  
 300 x 480 600 x 320

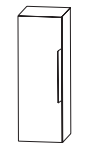

HBA-5130 L (R)  
 HBA-5560-1W  
 300 / 400 / 600 x 800

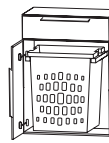

MNA-8330 L (R)  
 MNA-8360-1W  
 300 / 400 / 600 x 1280

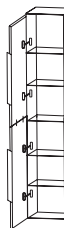
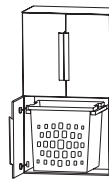

HNA-0330-11 L (R)  
 HNA-0260-01  
 300 / 400 / 600 x 1600

Abbildungen mit Griffleiste. Weitere Ergänzungsschränke finden Sie in der Typenliste.  
 Technical drawings with handle bar. You will find more add-on units in the type list.  
 Les exemples de composition avec profilé poignée. Autres armoires supplémentaires, voir catalogue.  
 Afbeeldingen zijn met greeplijst. Meer bijpassende kasten vindt u in de typelijst.

Breite x Höhe in mm  
 Width x height in mm  
 Largeur x hauteur en mm  
 Breedte x hoogte in mm



Planungsbeispiele Spiegel - Auszug aus dem Typenplan

Planning proposals mirrors - part of the type list

Exemples de composition miroir et armoires de toilette miroir - extrait du plan type

Spiegelkasten - getoonde kasten zijn een selectie uit de kast mogelijkheden

Türen / Auszüge / Schubkästen mit Dämpfung  
Doors / pull out units / drawers with buffered closing  
Portes / tiroirs / coulissants avec amortisseur  
Deuren en lades met softclose

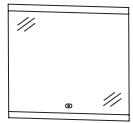

FSB-4360-01  
600 x 640

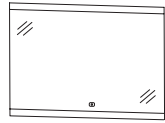

FSB-4390-01  
900 x 640

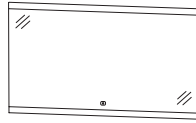

FSB-4312-01  
1200 x 640

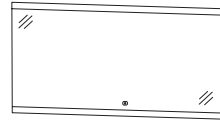

FSB-4314-01  
1400 x 640

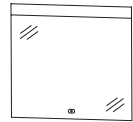

FSB-4360-02  
600 x 640

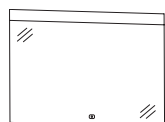

FSB-4390-02  
900 x 640

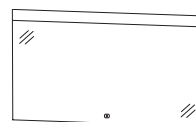

FSB-4312-02  
1200 x 640

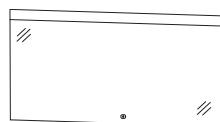

FSB-4314-02  
1400 x 640

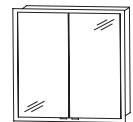

S2A-5360-E1  
651 x 851

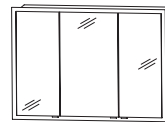

S2A-5390-E1  
951 x 851

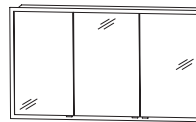

S2A-5312-E1  
1251 x 851

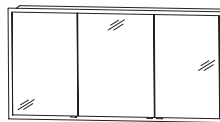

S2A-5314-E1  
1451 x 851

Planungsbeispiele Waschtische - Auszug aus dem Typenplan

Planning proposals washbasins - part of the type list

Exemples de composition plans vasque - extrait du plan type

Sets van wastafels en wastafelonderkasten - getoonde kasten zijn een selectie uit de kast mogelijkheden



WTA-S111-1  
WP-5063-FO  
SET-386S-2B  
626 x 600

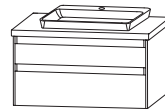

WTA-S111-1  
WP-5093-FO  
SET-389S-2B  
926 x 600

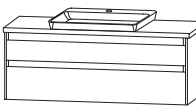

WTA-S111-1  
WP-5123-FO  
SET-382S-2B  
1226 x 600

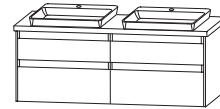

2x WTA-S111-1  
WP-5143-FO  
SET-3814-2B  
1426 x 600

Abbildungen mit Mineralguss-Aufsatzwaschtisch, auch in Keramik erhältlich.  
Technical drawing with cast mineral top-mounted washbasin, also available in ceramic.  
Les exemples de composition avec vasque à poser en matériau de synthèse sont également disponibles en céramique.  
Abbildungen zijn met minerale wastafels, keramische wastafels zijn ook mogelijk.

Ergänzungsschränke - Auszug aus dem Typenplan

Additional cabinets - part of the type list

Meubles complémentaires - extrait du plan type

Losse kasten - getoonde kasten zijn een selectie uit de kast mogelijkheden

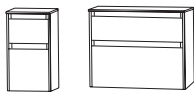

UNA-383D-GL  
UNA-386D-GL  
322 / 622 x 490

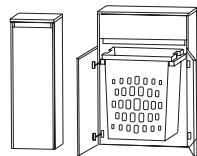

HBA-513D-GL (L)  
HBA-556D-WG  
322 / 622 x 840

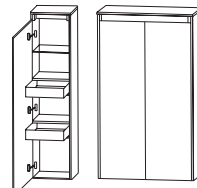

MNA-843D-GL L (R)  
MNA-816D-GL  
322 / 622 x 1320

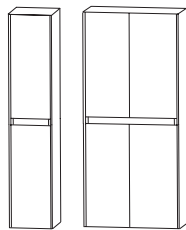

HNA-033D-GL L (R)  
HNA-036D-GL  
320 / 620 x 1630

Planungsbeispiele Spiegel - Auszug aus dem Typenplan

Planning proposals mirrors - part of the type list

Exemples de composition miroir et armoires de toilette miroir - extrait du plan type

Spiegelkasten - getoonde kasten zijn een selectie uit de kast mogelijkheden

Breite x Höhe in mm  
Width x height in mm  
Largeur x hauteur en mm  
Breedte x hoogte in mm

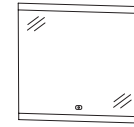

FSB-4360-01  
600 x 640

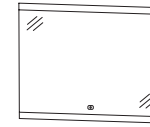

FSB-4380-01  
800 x 640

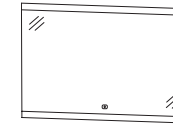

FSB-4310-01  
1000 x 640

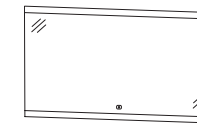

FSB-4312-01  
1200 x 640

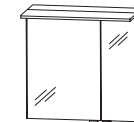

SET-4360-07 L (R)  
600 x 660

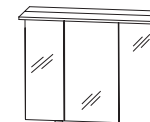

SET-4380-07  
800 x 660

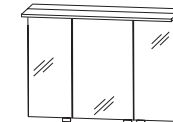

SET-4310-07  
1000 x 660

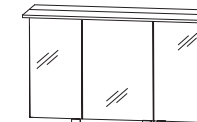

SET-4312-07  
1200 x 660

Planungsbeispiele Waschtische - Auszug aus dem Typenplan

Planning proposals washbasins - part of the type list

Exemples de composition plans vasque - extrait du plan type

Sets van wastafels en wastafelonderkasten - getoonde kasten zijn een selectie uit de kast mogelijkheden



WTM-4806-1  
WUA-4360-2G  
620 x 690

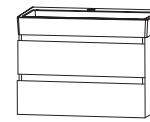

WTM-4808-1  
WUA-4380-2G  
810 x 690

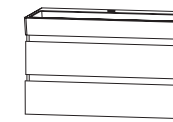

WTM-4810-1  
WUA-4310-2G  
1020 x 690

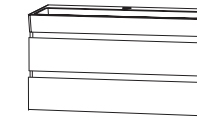

WTM-4812-1  
WUA-4312-2G  
1220 x 690

„Squared“ Keramik  
“Squared“ ceramic  
“Squared“ céramique  
“Squared“ keramiek

Abbildungen grifflos, auch mit Griffleiste möglich.  
Technical drawings handleless, also available with strip handle.  
Les exemples de composition sans poignées également possible avec profilé poignées.  
Abbildungen zijn greeploos, met greeplijst zijn ook mogelijk.

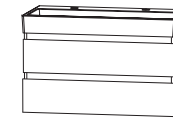

WTM-4821-1  
WUA-4310-2G  
1020 x 690



WTM-482D-1  
WUA-432D-2G  
1220 x 690

Ergänzungsschränke - Auszug aus dem Typenplan

Additional cabinets - part of the type list

Meubles complémentaires - extrait du plan type

Losse kasten - getoonde kasten zijn een selectie uit de kast mogelijkheden

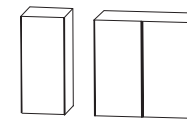

OGA-4130-TG L (R)  
OGA-4160-TG  
300 / 600 x 640

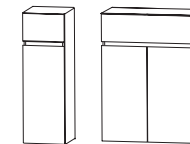

HBA-5530-TG L (R)  
HBA-5560-TG  
300 / 600 x 830

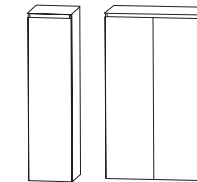

MNA-8130-TG L (R)  
MNA-8160-TG  
300 / 600 x 1310

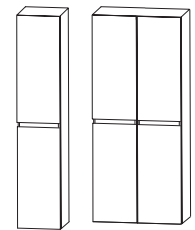

HNA-0330-TG L (R)  
HNA-0360-TG  
300 / 600 x 1630



# SLIM LINE

Planungsbeispiele Spiegel  
 Planning proposals mirrors  
 Exemples de composition miroir et armoires de toilette miroir  
 Spiegel / Spiegelkasten

Breite x Höhe in mm  
 Width x height in mm  
 Largeur x hauteur en mm  
 Breedte x hoogte in mm

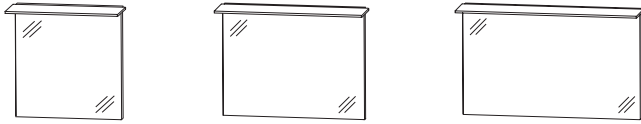

FSA-416B-29 600 x 640  
 FSA-419B-29 900 x 640  
 FSA-412B-29 1200 x 640

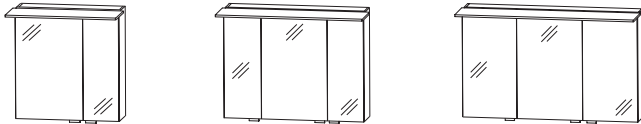

SDA-436L-01 (R) 600 x 640  
 SDA-4390-01 900 x 640  
 SDA-4312-01 1200 x 640

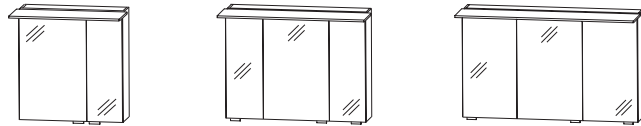

STA-436L-01 (R) 600 x 640  
 STA-4390-01 900 x 640  
 STA-4312-01 1200 x 640

Planungsbeispiele Waschtische  
 Planning proposals washbasins  
 Exemples de composition plans vasque  
 Sets van wastafels en wastafelonderkasten

Türen / Auszüge / Schubkästen mit Dämpfung  
 Doors / pull out units / drawers with buffered closing  
 Portes / tiroirs / coulissants avec amortisseur  
 Deuren en lades met softclose



SET-SL60-MG 612 x 501  
 SET-SL90-MG 912 x 501  
 SET-SL12-MG 1212 x 501

**STONE-PLUS®**  
 Ergänzungsschränke - Auszug aus dem Typenplan  
 Additional cabinets - part of the type list  
 Meubles complémentaires - extrait du plan type  
 Losse kasten - getoonde kasten zijn een selectie uit de kast mogelijkheden

Abbildungen mit Griffleiste, auch in grifflos möglich.  
 Technical drawings with handle bar, also available handleless.  
 Les exemples de composition avec profilé poignées  
 également possible sans poignées.  
 Afbeeldingen zijn met greeplijst, greeploos zijn ook mogelijk.

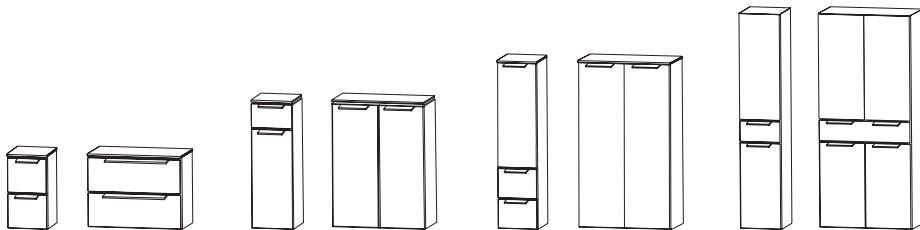

UNA-363A-29 300 / 600 x 490  
 UNA-366A-29 300 / 600 x 490  
 HBA-553A-29 L (R) 300 / 600 x 810  
 HBA-516A-29 300 / 600 x 810  
 MNA-873A-29 L (R) 300 / 600 x 1290  
 MNA-816A-29 300 / 600 x 1290  
 HNA-0530-29 L (R) 300 / 600 x 1600  
 HNA-0560-29 300 / 600 x 1600

# KAO LINE

Planungsbeispiele Spiegel  
 Planning proposals mirrors  
 Exemples de composition miroir et armoires de toilette miroir  
 Spiegelkasten

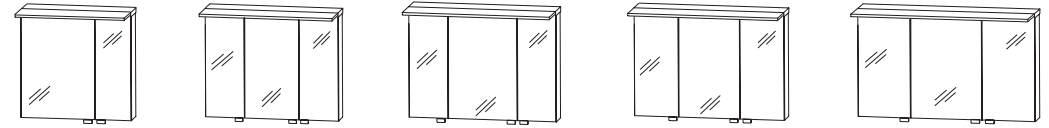

SET-4360-07 L (R) 600 x 660  
 SET-4380-07 800 x 660  
 SET-4390-07 900 x 660  
 SET-4310-07 1000 x 660  
 SET-4312-07 1200 x 660

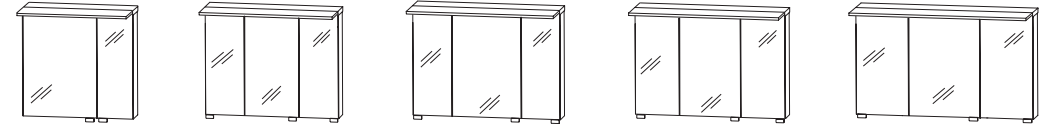

SET-4360-06 L (R) 600 x 660  
 SET-4380-06 800 x 660  
 SET-4390-06 900 x 660  
 SET-4310-06 1000 x 660  
 SET-4312-06 1200 x 660

Planungsbeispiele Waschtische  
 Planning proposals washbasins  
 Exemples de composition plans vasque  
 Sets van wastafels en wastafelonderkasten



SET-KL60-1 660 x 530  
 SET-KL80-1 860 x 530  
 SET-KL90-1 960 x 530  
 SET-KL10-1 1060 x 530  
 SET-KL12-1 1260 x 530

Keramik  
 ceramic  
 céramique  
 keramiek

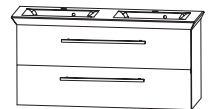

SET-KL12-D1 1260 x 530



SET-KL2D-1 1260 x 530

Breite x Höhe in mm  
 Width x height in mm  
 Largeur x hauteur en mm  
 Breedte x hoogte in mm

Türen / Auszüge / Schubkästen mit Dämpfung  
 Doors / pull out units / drawers with buffered closing  
 Portes / tiroirs / coulissants avec amortisseur  
 Deuren en lades met softclose



Planungsbeispiele  
 Planning examples  
 Exemples de composition  
 Sets

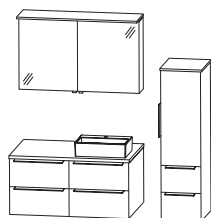

ASK-4312-2  
 1206 + 402

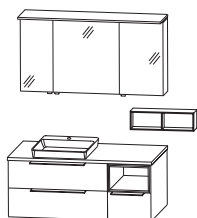

ASK-0113-1  
 1306

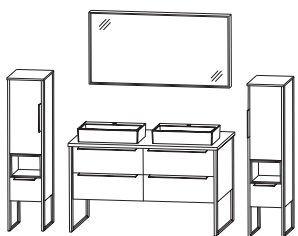

ASK-4312-1  
 343 + 1246 + 343

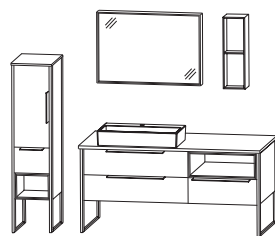

ASK-4315-1  
 342 + 1546

Breite in mm  
 Width in mm  
 Largeur en mm  
 Breedte in mm

Türen / Auszüge / Schubkästen mit Dämpfung  
 Doors / pull out units / drawers with buffered closing  
 Portes / tiroirs / coulissants avec amortisseur  
 Deuren en lades met softclose

Badmöbelkombinationen von 606 bis 1546 mm Breite erhältlich.  
 Bathroom furniture combinations available in widths from 606 to 1546 mm.  
 Compositions de salle de bains disponibles en largeur de 606 à 1546 mm.  
 Badkamermeubelcombinaties van 606 tot 1546 mm breed verkrijgbaar.

Planungsbeispiele Spiegel  
 Planning proposals mirrors  
 Exemples de composition miroir et armoires de toilette miroir  
 Spiegelkasten

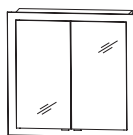

S2A-4360-51  
 720 x 760

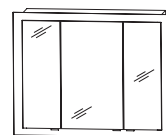

S2A-4390-51  
 1020 x 760

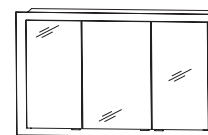

S2A-4312-51  
 1320 x 760

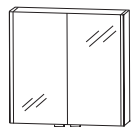

S2A-446B-04  
 600 x 640

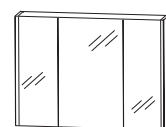

S2A-449B-04  
 900 x 640



S2A-442B-04  
 1200 x 640

Breite x Höhe in mm  
 Width x height in mm  
 Largeur x hauteur en mm  
 Breedte x hoogte in mm

Türen / Auszüge / Schubkästen mit Dämpfung  
 Doors / pull out units / drawers with buffered closing  
 Portes / tiroirs / coulissants avec amortisseur  
 Deuren en lades met softclose

Planungsbeispiele Waschtische - Auszug aus dem Typenplan  
 Planning proposals washbasins - part of the type list  
 Exemples de composition plans vasque - extrait du plan type

Sets van wastafels en wastafelonderkasten - getoonde kasten zijn een selectie uit de kast mogelijkheden



SWM-9506-B3  
 WUA-3360-E9  
 606 x 510

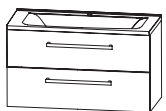

SWM-9509-B3  
 WUA-3390-E9  
 906 x 510



SWM-9512-B3  
 WUA-3312-E9  
 1206 x 510

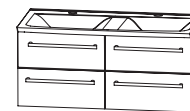

SWM-952D-B3  
 WUA-3312-9  
 1206 x 510

evermite®

Abbildungen mit evermite® Waschtisch, auch in Glas erhältlich.  
 Technical drawing with evermite® washbasin, also available in glass.  
 Les exemples de composition avec evermite® plan vasque sont également disponible en verre.  
 Afbeeldingen zijn met evermite® wastafels, glazen wastafels zijn ook mogelijk.

Ergänzungsschränke - Auszug aus dem Typenplan  
 Additional cabinets - part of the type list  
 Meubles complémentaires - extrait du plan type  
 Losse kasten - getoonde kasten zijn een selectie uit de kast mogelijkheden

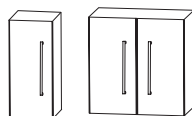

OGA-4130 L (R)  
 OGA-4160  
 300 / 600 x 640

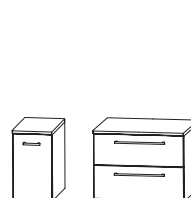

UNA-3130-A1 L (R)  
 UNA-3660-A1  
 300 / 600 x 501

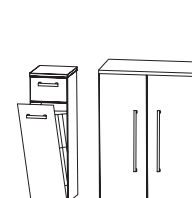

HBA-553W-A1  
 HBA-5160-A1  
 300 / 600 x 821

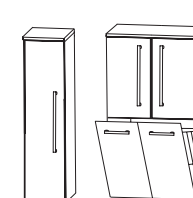

MNA-8130-A1 L (R)  
 MNA-836W-A2  
 300 / 600 x 1301

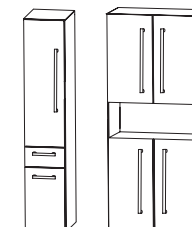

HNA-0530-01 L (R)  
 HNA-0260-02  
 300 / 600 x 1600



# ICE LINE

Planungsbeispiele Spiegel  
 Planning proposals mirrors  
 Exemples de composition miroir et armoires de toilette miroir  
 Spiegels / Spiegelkasten

Breite x Höhe in mm  
 Width x height in mm  
 Largeur x hauteur en mm  
 Breedte x hoogte in mm

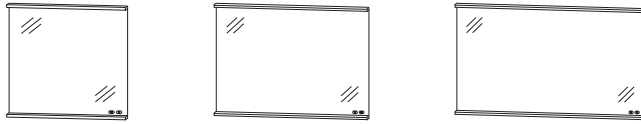

FSA-4360-89 600 x 672  
 FSA-4390-89 900 x 672  
 FSA-4312-89 1200 x 672

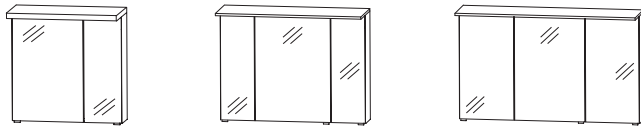

S2A-436L-89 600 x 650  
 S2A-439A-89 900 x 650  
 S2A-431A-89 1200 x 650

Abbildungen mit Griffleiste, auch in grifflos (push-to-open) möglich.  
 Technical drawings with handle bar, also available handleless (push-to-open).  
 Les exemples de composition avec profilé poignée également possible sans poignées (push-to-open).  
 Afbeeldingen zijn met greeplijst, greeploos (push-to-open) zijn ook mogelijk.

Planungsbeispiele Waschtische  
 Planning proposals washbasins  
 Exemples de composition plans vasque  
 Sets van wastafels en wastafelonderkasten

Türen / Auszüge / Schubkästen mit Dämpfung  
 Doors / pull out units / drawers with buffered closing  
 Portes / tiroirs / coulissants avec amortisseur  
 Deuren en lades met softclose

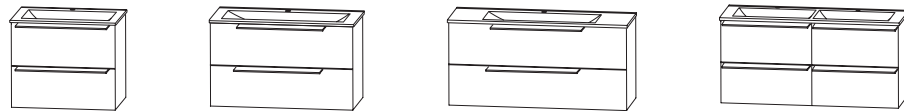

WMS-5060-61 WUA-3360-30 620 x 495  
 WMS-5090-61 WUA-3390-30 920 x 495  
 WMS-5120-61 WUA-3312-30 1220 x 495  
 WMS-7120-61 WUA-332D-30 1220 x 495

**STONEPLUS®**

Abbildungen mit STONEPLUS® Waschtisch, auch in Glas erhältlich.  
 Technical drawing with STONEPLUS® washbasin, also available in glass.  
 Exemples de composition avec STONEPLUS® plan vasque, également disponible en verre.  
 Afbeeldingen zijn met STONEPLUS® wastafels, glazen wastafels zijn ook mogelijk.

Ergänzungsschränke - Auszug aus dem Typenplan  
 Additional cabinets - part of the type list  
 Meubles complémentaires - extrait du plan type  
 Losse kasten - getoonde kasten zijn een selectie uit de kast mogelijkheden

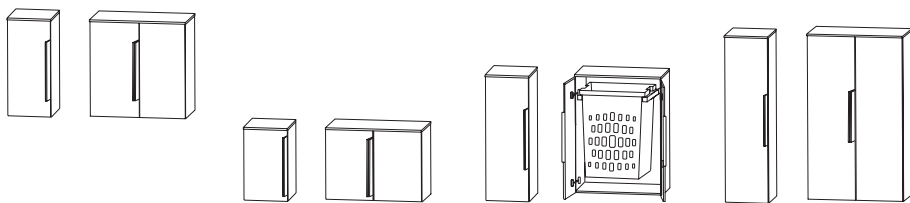

OGA-413A-3 L (R) OGA-416A-3 308 / 608 x 646  
 UNA-313A-3 L (R) UNA-316A-3 308 / 608 x 486  
 HBA-513A-3 L (R) HBA-516W-A3 308 / 608 x 806  
 MNA-813A-3 L (R) MNA-816A-3 308 / 608 x 1286

# SWING

Planungsbeispiele Spiegel  
 Planning proposals mirrors  
 Exemples de composition miroir et armoires de toilette miroir  
 Spiegelkasten

Breite x Höhe in mm  
 Width x height in mm  
 Largeur x hauteur en mm  
 Breedte x hoogte in mm



SET-4390-3 R (L) 900 x 680  
 SET-4112-3R (L) 1200 x 680  
 SET-4014-3R (L) 1400 x 680  
 SET-4118-3 1800 x 680

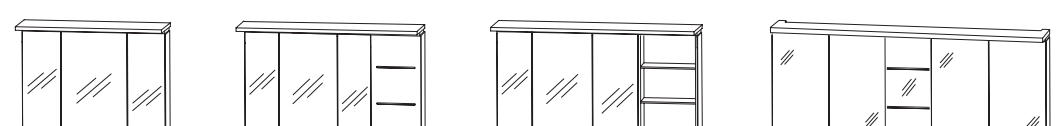

SET-4390-2 900 x 680  
 SET-4012-2R (L) 1200 x 680  
 SET-4114-2R (L) 1400 x 680  
 SET-4018-2 L (R) 1800 x 680

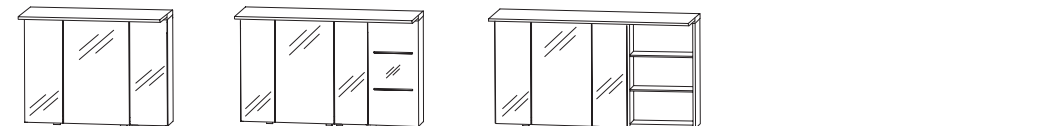

SET-4390-6 900 x 660  
 SET-4012-6R (L) 1200 x 660  
 SET-4114-6R (L) 1400 x 660

Planungsbeispiele Waschtische  
 Planning proposals washbasins  
 Exemples de composition plans vasque  
 Sets van wastafels en wastafelonderkasten

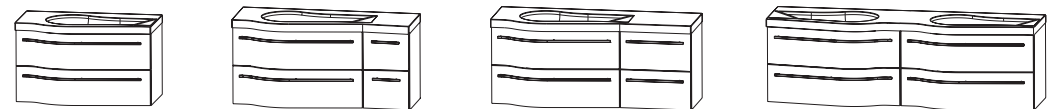

WMM-529R-21 (L) WUA-3690-1M R (L) 906 x 495  
 WMM-522R-21 (L) WUA-3690-1M R (L) + UTA-3630-1M 1206 x 495  
 WMM-524R-21 (L) WUA-3690-1M R (L) + UTA-3650-1M 1406 x 495  
 WMM-528D-21 WUA-3690-1M L + WUA-3690-1M R 1806 x 495

**evermite®**

Abbildungen mit evermite® Waschtisch, auch in Glas erhältlich.  
 Technical drawing with evermite® washbasin, also available in glass.  
 Les exemples de composition avec evermite® plan vasque sont également disponible en verre.  
 Afbeeldingen zijn met evermite® wastafels, glazen wastafels zijn ook mogelijk.

Türen / Auszüge / Schubkästen mit Dämpfung  
 Doors / pull out units / drawers with buffered closing  
 Portes / tiroirs / coulissants avec amortisseur  
 Deuren en lades met softclose



# FINE LINE

Planungsbeispiele Spiegel  
 Planning proposals mirrors  
 Exemples de composition miroir et armoires de toilette miroir  
 Spiegelkasten

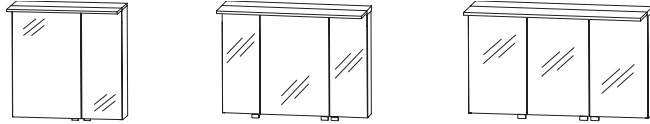

S2A-4360-78 L (R) 602 x 659  
 S2A-4390-78 902 x 659  
 S2A-4312-78 1202 x 659

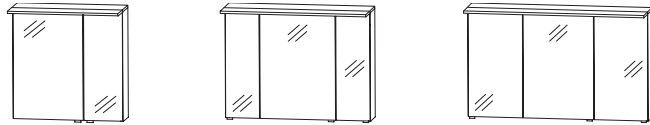

S2A-436S-08 L (R) 602 x 659  
 S2A-439S-08 902 x 659  
 S2A-432S-08 1202 x 659

Planungsbeispiele Waschtische  
 Planning proposals washbasins  
 Exemples de composition plans vasque  
 Sets van wastafels en wastafelonderkasten



WMS-4060-61 WUA-3760-28 620 x 495  
 WMS-4090-61 WUA-3790-28 920 x 495  
 WMS-4120-61 WUA-3712-28 1220 x 495

**STONEPLUS®**



WTK-7065-1 WUA-3760-27 650 x 545  
 WTK-7095-1 WUA-3790-27 950 x 545  
 WTK-7125-1 WUA-3712-27 1250 x 545

Keramik  
 ceramic  
 céramique  
 keramiek

Breite x Höhe in mm  
 Width x height in mm  
 Largeur x hauteur en mm  
 Breedte x hoogte in mm

Türen / Auszüge / Schubkästen mit Dämpfung  
 Doors / pull out units / drawers with buffered closing  
 Portes / tiroirs / coulissants avec amortisseur  
 Deuren en lades met softclose

# CRESCENDO

Planungsbeispiele Spiegel  
 Planning proposals mirrors  
 Exemples de composition miroir et armoires de toilette miroir  
 Spiegels / Spiegelkasten

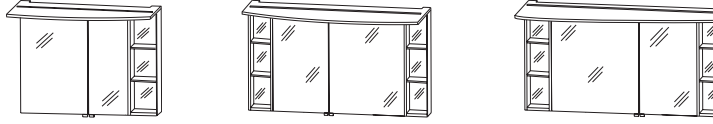

S2A-439R 76 (L) 900 x 650  
 S2A-4312-76 L (R) 1200 x 650  
 S2A-4314-76 R (L) 1400 x 650

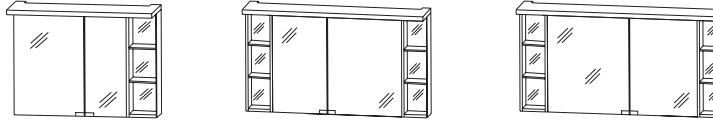

S2A-439R-26 (L) 900 x 668  
 S2A-4312-26 L (R) 1200 x 668  
 S2A-4314-26 R (L) 1400 x 668

Planungsbeispiele Waschtische  
 Planning proposals washbasins  
 Exemples de composition plans vasque  
 Sets van wastafels en wastafelonderkasten

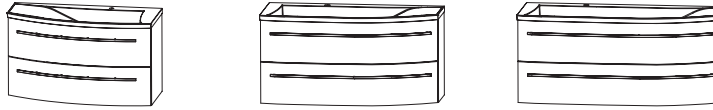

SWM-109L-1 (R) WUA-3690-09 L (R) 906 x 510  
 SWM-112R-1 (L) WUA-3612-09 R (L) 1206 x 510  
 SWM-114R-1 (L) WUA-3614-09 R (L) 1406 x 510

Mineralguss  
 cast mineral  
 matériau de synthèse  
 mineraalmarmor

Breite x Höhe in mm  
 Width x height in mm  
 Largeur x hauteur en mm  
 Breedte x hoogte in mm

Türen / Auszüge / Schubkästen mit Dämpfung  
 Doors / pull out units / drawers with buffered closing  
 Portes / tiroirs / coulissants avec amortisseur  
 Deuren en lades met softclose

Abbildungen mit Mineralguss-Waschtisch, auch in evermite® oder Glas erhältlich.  
 Technical drawing with cast mineral washbasin, also available in evermite® or glass.  
 Les exemples de composition avec plan vasque en matériau de synthèse sont également disponible en evermite® ou en verre.  
 Afbeeldingen zijn met minerale wastafels, evermite® en glazen wastafels zijn ook mogelijk.

# COOL

Planungsbeispiele Spiegel  
 Planning proposals mirrors  
 Exemples de composition miroir et armoires de toilette miroir  
 Spiegelkasten

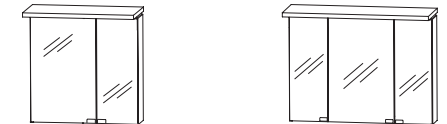

S2A-436A-20 L (R) 600 x 680  
 S2A-439A-20 900 x 680



S2A-436A-69 L (R) 600 x 680  
 S2A-439A-69 900 x 680

Planungsbeispiele Waschtische  
 Planning proposals washbasins  
 Exemples de composition plans vasque  
 Sets van wastafels en wastafelonderkasten

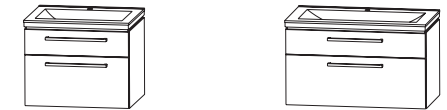

WMS-5060-61 WUA-386D-1M 620 x 539  
 WMS-5090-61 WUA-389D-1M 920 x 539

**STONEPLUS®**

Breite x Höhe in mm  
 Width x height in mm  
 Largeur x hauteur en mm  
 Breedte x hoogte in mm

Türen / Auszüge / Schubkästen mit Dämpfung  
 Doors / pull out units / drawers with buffered closing  
 Portes / tiroirs / coulissants avec amortisseur  
 Deuren en lades met softclose

Abbildungen mit STONEPLUS® Waschtisch, auch in Glas oder Keramik erhältlich.  
 Technical drawing with STONEPLUS® washbasin, also available in glass or ceramic.  
 Exemples de composition avec STONEPLUS® plan vasque sont également disponible en verre ou en céramique.  
 Afbeeldingen zijn met STONEPLUS® wastafels, glazen en keramische wastafels zijn ook mogelijk.



Planungsbeispiele Spiegel  
 Planning proposals mirrors  
 Exemples de composition miroir et armoires de toilette miroir  
 Spiegels / Spiegelkasten

Breite x Höhe in mm  
 Width x height in mm  
 Largeur x hauteur en mm  
 Breedte x hoogte in mm

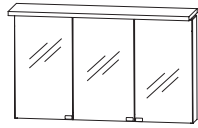

S2A-431A-20  
 1200 x 680

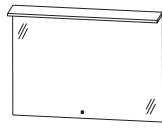

FSB-4190-01  
 900 x 652

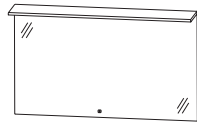

FSB-4112-01  
 1200 x 652

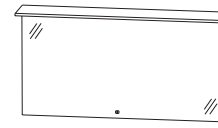

FSB-4114-01  
 1400 x 652

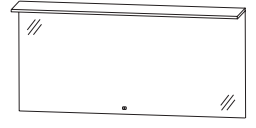

FSB-4116-01  
 1600 x 652

Türen / Auszüge / Schubkästen mit Dämpfung  
 Doors / pull out units / drawers with buffered closing  
 Portes / tiroirs / coulissants avec amortisseur  
 Deuren en lades met softclose

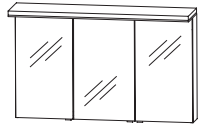

S2A-431A-69  
 1200 x 680

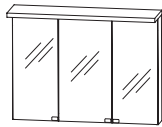

S2A-4390-16  
 900 x 668

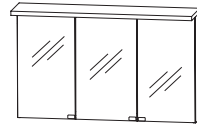

S2A-4312-16  
 1200 x 668

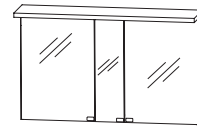

S2A-4312-15  
 1200 x 668

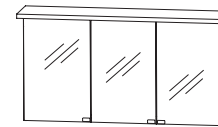

S2A-4314-16  
 1400 x 668

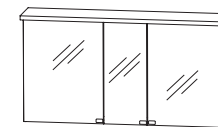

S2A-4314-15  
 1400 x 668

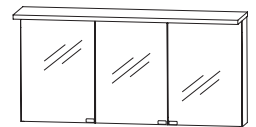

S2A-4316-15  
 1600 x 668

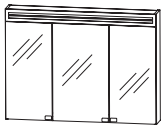

S2A-5890-6  
 900 x 720

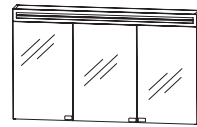

S2A-5812-6  
 1200 x 720

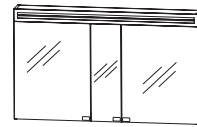

S2A-5812-5  
 1200 x 720

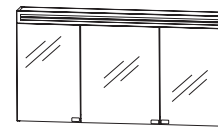

S2A-5814-6  
 1400 x 720

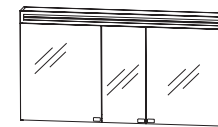

S2A-5814-5  
 1400 x 720

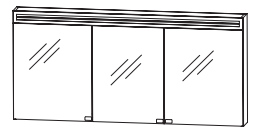

S2A-5816-5  
 1600 x 720

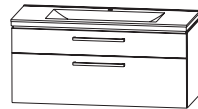

WMS-5120-61  
 WUA-381D-1M  
 1220 x 539

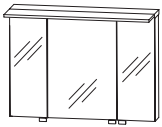

S2A-4390-78  
 900 x 660

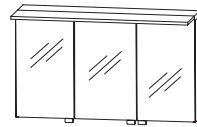

S2A-4312-78  
 1200 x 660

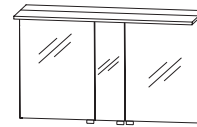

S2A-4312-77  
 1200 x 660

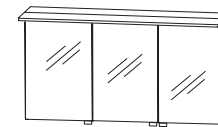

S2A-4314-78  
 1400 x 660

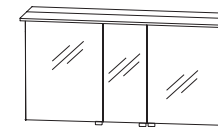

S2A-4314-77  
 1400 x 660

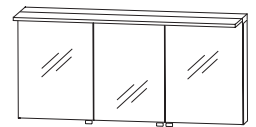

S2A-4316-77  
 1600 x 660

Planungsbeispiele Waschtische  
 Planning proposals washbasins  
 Exemples de composition plans vasque  
 Sets van wastafels en wastafelonderkasten



WMS-7120-61  
 WUA-381D-3M  
 1220 x 539



WME-919E-61  
 WUA-3390-07  
 906 x 498



WME-912E-61  
 WUA-3312-07  
 1206 x 498

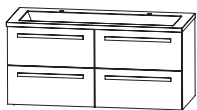

WME-912D-61  
 WUA-3312-7  
 1206 x 498



WME-914E-61  
 WUA-3314-07  
 1406 x 498

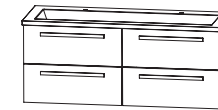

WME-914D-61  
 WUA-3314-7  
 1406 x 498

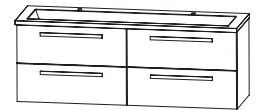

WME-916D-61  
 WUA-3316-7  
 1606 x 498

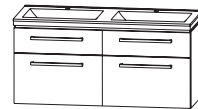

WMS-7120-61  
 WUA-341D-3M  
 1220 x 539

**STONEPLUS®**

Abbildungen mit STONEPLUS® Waschtisch, auch in „evermite“ oder Glas erhältlich.  
 Technical drawing with STONEPLUS® washbasin, also available in „evermite“ or glass.  
 Les exemples de composition avec STONEPLUS® plan vasque sont également disponible en „evermite“ ou en verre.  
 Afbeeldingen zijn met STONEPLUS® wastafels, „evermite“ en glazen wastafels zijn ook mogelijk.



# CLASSIC LINE

Planungsbeispiele Spiegel  
 Planning proposals mirrors  
 Exemples de composition miroir et armoires de toilette miroir  
 Spiegelkasten

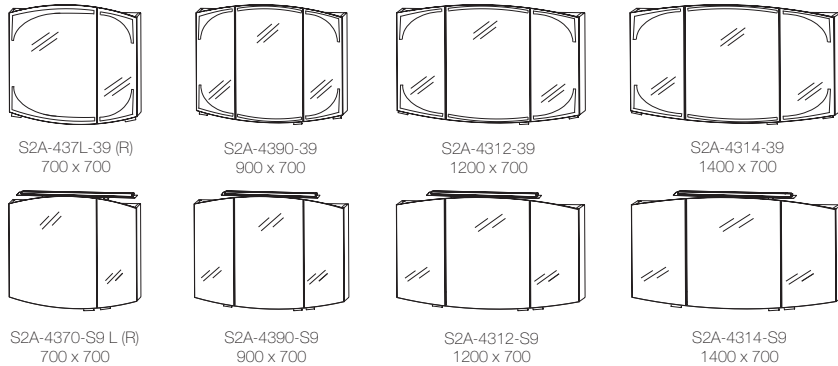

S2A-437L-39 (R)  
700 x 700

S2A-4390-39  
900 x 700

S2A-4312-39  
1200 x 700

S2A-4314-39  
1400 x 700

S2A-4370-S9 L (R)  
700 x 700

S2A-4390-S9  
900 x 700

S2A-4312-S9  
1200 x 700

S2A-4314-S9  
1400 x 700

Planungsbeispiele Waschtische  
 Planning proposals washbasins  
 Exemples de composition plans vasque  
 Sets van wastafels en wastafelonderkasten

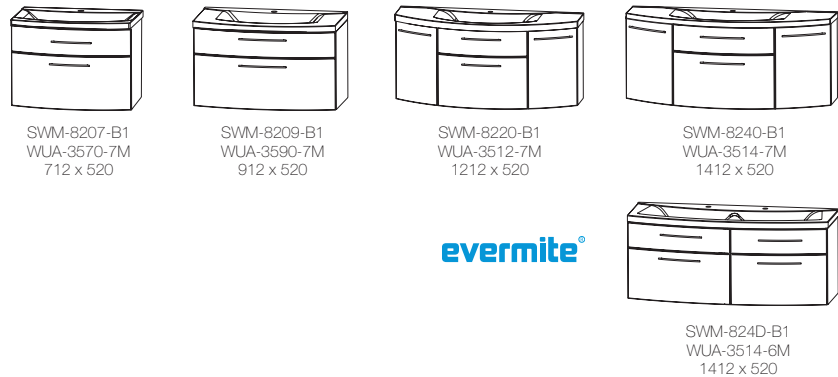

SWM-8207-B1  
WUA-3570-7M  
712 x 520

SWM-8209-B1  
WUA-3590-7M  
912 x 520

SWM-8220-B1  
WUA-3512-7M  
1212 x 520

SWM-8240-B1  
WUA-3514-7M  
1412 x 520

**evermite®**

SWM-824D-B1  
WUA-3514-6M  
1412 x 520

Breite x Höhe in mm  
 Width x height in mm  
 Largeur x hauteur en mm  
 Breedte x hoogte in mm

Türen / Auszüge / Schubkästen mit Dämpfung  
 Doors / pull out units / drawers with buffered closing  
 Portes / tiroirs / coulissants avec amortisseur  
 Deuren en lades met softclose

Abbildungen mit evermite® Waschtisch, auch in Glas erhältlich.  
 Technical drawing with "evermite" washbasin, also available in glass.  
 Les exemples de composition avec evermite® plan vasque sont également disponible en en verre.  
 Afbeeldingen is met evermite® wastafels, glazen wastafels zijn ook mogelijk.

# VARIADO 2.0

Planungsbeispiele  
 Planning examples  
 Exemples de composition  
 Sets

Breite in mm  
 Width in mm  
 Largeur en mm  
 Breedte in mm

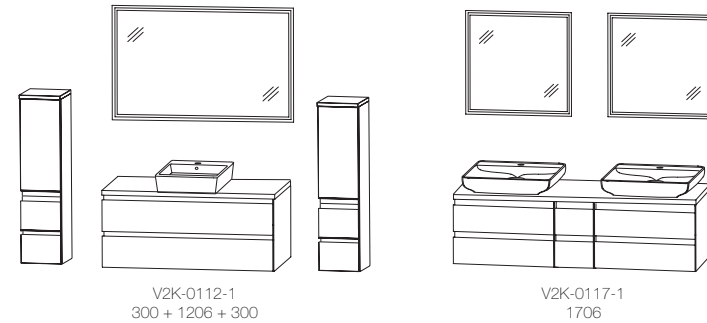

V2K-0112-1  
300 + 1206 + 300

V2K-0117-1  
1706

Keramik  
 ceramic  
 céramique  
 keramiek

Badmöbelkombinationen in 706, 1006, 1206, 1406 und 1706 mm Breite erhältlich.  
 Bathroom furniture combinations available in widths 706, 1006, 1206, 1406 and 1706 mm.  
 Compositions de salle de bains disponibles en largeur de 706, 1006, 1206, 1406 et 1706 mm.  
 Badkamermeubelcombinaties in 706, 1006, 1206, 1406 en 1706 mm breed verkrijgbaar.

Planungsbeispiele Unterschränke  
 Planning proposals base units  
 Exemples de composition éléments sous plan vasque  
 Onderkasten breedtes

Abbildungen grifflos, auch mit Griffleiste möglich.  
 Technical drawings handleless, also available with strip handle.  
 Les exemples de composition sans poignées également possible avec profilé poignées.  
 Afbeeldingen zijn greeploos, met greeplijst zijn ook mogelijk.

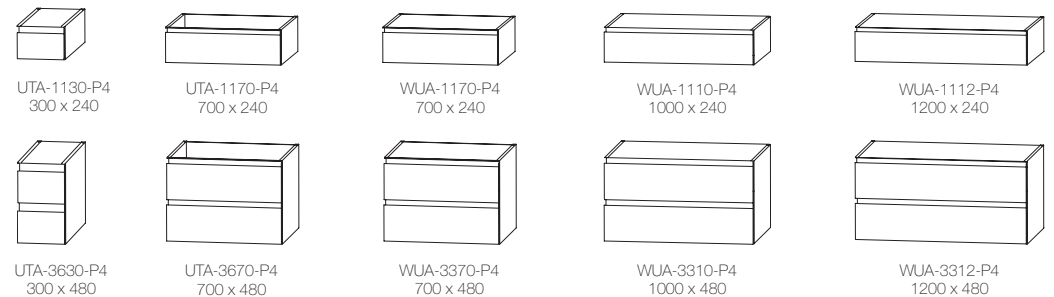

UTA-1130-P4  
300 x 240

UTA-1170-P4  
700 x 240

WUA-1170-P4  
700 x 240

WUA-1110-P4  
1000 x 240

WUA-1112-P4  
1200 x 240

UTA-3630-P4  
300 x 480

UTA-3670-P4  
700 x 480

WUA-3370-P4  
700 x 480

WUA-3310-P4  
1000 x 480

WUA-3312-P4  
1200 x 480

Ergänzungsschränke - Auszug aus dem Typenplan  
 Additional cabinets - part of the type list  
 Meubles complémentaires - extrait du plan type  
 Losse kasten - getoonde kasten zijn een selectie uit de kast mogelijkheden

Türen / Auszüge / Schubkästen mit Dämpfung  
 Doors / pull out units / drawers with buffered closing  
 Portes / tiroirs / coulissants avec amortisseur  
 Deuren en lades met softclose

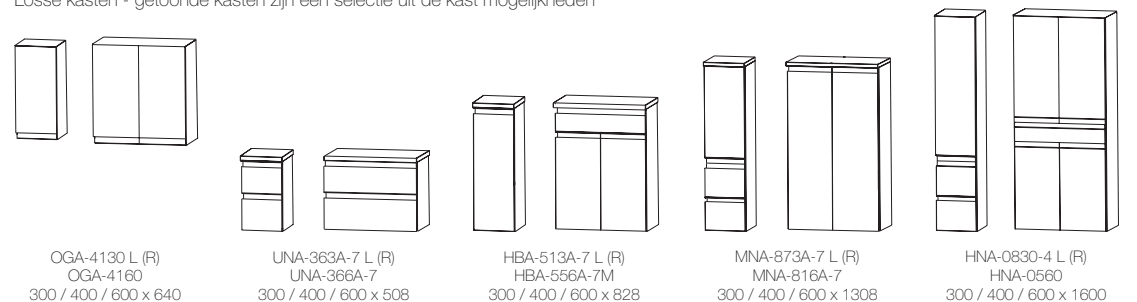

OGA-4130 L (R)  
OGA-4160  
300 / 400 / 600 x 640

UNA-363A-7 L (R)  
UNA-366A-7  
300 / 400 / 600 x 508

HBA-513A-7 L (R)  
HBA-556A-7M  
300 / 400 / 600 x 828

MNA-873A-7 L (R)  
MNA-816A-7  
300 / 400 / 600 x 1308

HNA-0830-4 L (R)  
HNA-0560  
300 / 400 / 600 x 1600



# STAR LINE

# ROUNDS

# FINE LINE

# CRESCENDO

Ergänzungsschränke - Auszug aus dem Typenplan  
 Additional cabinets - part of the type list  
 Meubles complémentaires - extrait du plan type  
 Losse kasten - getoonde kasten zijn een selectie uit de kast mogelijkheden

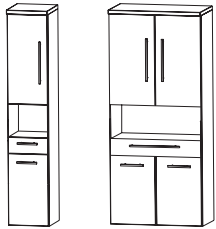

300 / 400 / 600 x 1628

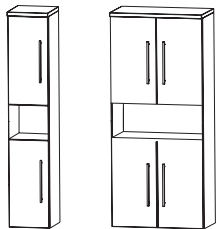

300 / 400 / 600 x 1628

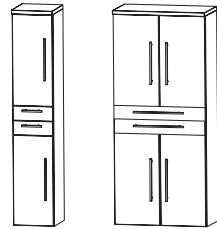

300 / 400 / 600 x 1628

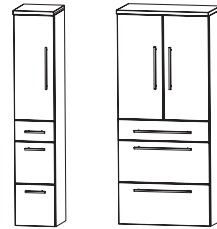

300 / 400 / 600 x 1628

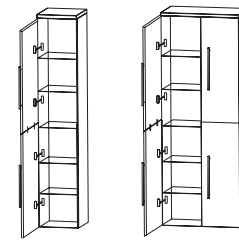

300 / 400 / 600 x 1628



300 x 1600

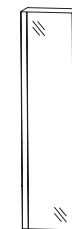

400 x 1600

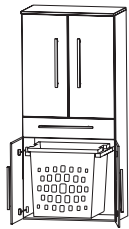

600 x 1628

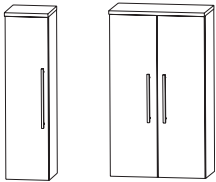

300 / 400 / 600 x 1308



300 / 400 / 600 x 1308

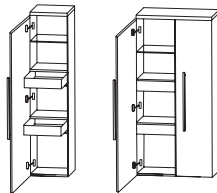

300 / 400 / 600 x 1308



400 x 1280

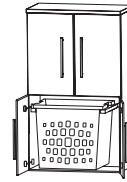

600 x 1308

Abbildungen können je nach Programm abweichen (Höhenmaße, Ablageplatten, Griffpositionen, etc.).  
 Schauen Sie bitte in die Typenlisten, dort finden Sie auch die Artikelnummern der Ergänzungsschränke.

Illustrations can be different from the actual programs (heights, working tops, handle positions, etc.).  
 Please take a look at the type lists, where you can find also the article numbers for the additional cabinets.

Les représentations en image peuvent varier dans chaque programme (élévations, tablettes, positions des poignées, etc.).  
 Consultez la liste des références, vous trouverez aussi le numéro article des meubles complémentaires.

Afbeeldingen kunnen in ieder programma afwijken (hoogte, afdekbladen, greepposities, etc.).  
 Kijkt u bij de losse kasten, daar vindt ook u de bestelcode van uw kast.

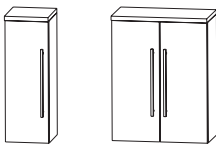

300 / 400 / 600 x 828



300 / 400 / 600 x 828

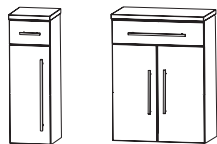

300 / 400 / 600 x 828



300 / 400 / 600 x 828

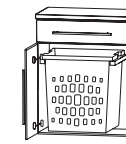

600 x 828

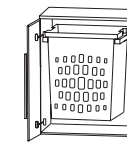

600 x 828

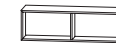

600 x 160



600 x 8

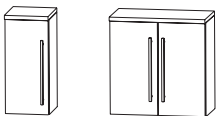

300 / 400 / 600 x 668



300 / 400 / 600 x 508



300 / 400 / 600 x 508

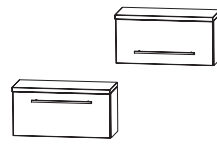

600 x 348

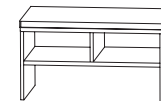

600 / 900 x 458



470 x 756

Breite x Höhe in mm  
 Width x height in mm  
 Largeur x hauteur en mm  
 Breedte x hoogte in mm

Türen / Auszüge / Schubkästen mit Dämpfung  
 Doors / pull out units / drawers with buffered closing  
 Portes / tiroirs / coulissants avec amortisseur  
 Deuren en lades met softclose

# CLASSIC LINE

# KAO LINE

# COOL LINE

# SWING



for guests



Weitere Möbel finden Sie in den Prospekten „KeraPLAN“ und „for guests“. Further bathroom furniture can be found in our brochures "KeraPLAN" and "for guests". Vous trouverez plus de meubles dans les brochures «KeraPLAN» et «for guests». Meer meubels zijn te vinden in de brochures "KeraPLAN" en "for guests".



Qualität ist Aufgabe und Ziel. Das „goldene M“ steht für geprüfte Qualität, garantierte Sicherheit und gesundes Wohnen. Es ist das einzige in Deutschland offiziell anerkannte Gütezeichen für Möbel und es ist der strengste Nachweis für überprüfte Möbelqualität und -sicherheit in Europa.

Quality is our mission and goal. The "Golden M" stands for tested quality, guaranteed safety and healthy living. It is Germany's only officially recognised quality seal for furniture and it is the strictest confirmation of tested furniture quality and safety in Europe.

Notre objectif: la qualité. Le «M d'or» garantit non seulement une qualité et une sécurité contrôlée mais aussi un habitat sain. Il est le seul label de qualité attribué aux meubles reconnu en Allemagne. En Europe, suite à une série de tests réalisés, ce cachet est la garantie optimale de la qualité et la sécurité des meubles.

Kwaliteit is onze taak en doelstelling. De "gouden M" staat voor geteste kwaliteit, veiligheid en gezond wonen gegarandeerd. Het is het enige officiële erkende label in Duitsland. Dit label geeft aan dat puris voldoet aan de strengste eisen van kwaliteit en veiligheid in Europa.



puris Bad GmbH & Co. KG · Hintern Gallberg 6a · D-59929 Brilon  
mail@puris.de · www.puris.de

Abbildungen und Angaben sind unverbindlich. Technische Änderungen vorbehalten. Illustrations and specifications are without obligation. Technical modifications reserved. Reproductions et données techniques sans engagement de notre part. Sous réserve de modifications techniques. Afbeeldingen en specificaties kunnen afwijken. Technische wijzigingen voorbehouden.



KeraPLAN

puris  
4life

spirit of bathrooms

